



TABLE OF CONTENTS

- TABLE OF CONTENTS 1
- MANUAL REVISION HISTORY 3
- IMPORTANT SAFETY NOTICE 4
- 1.0 General Information 5
 - 1.1 System Components 5
 - 1.2 Specifications 5
 - 1.2.1 Torque Ranges 5
 - 1.2.2 Electrical Specifications 6
 - 1.2.3 Environmental Specifications 6
 - 1.2.4 Cycle of Operation 6
- 2.0 Power Requirements 6
 - 2.1 AC Mains Power 6
 - 2.2 Earth Grounding Safety 7
 - 2.3 Ground Fault Current Interrupt (GFCI) 7
 - 2.4 Extension Cords 7
 - 2.5 Power Cycling 7
- 3.0 Tool System Assembly 7
 - 3.1 Tool Handle Description 7
 - 3.2 Controller Description 8
 - 3.3 Connecting the Tool Handle, the Controller and the Power 9
- 4.0 Touch Display Interface 9
 - 4.1 Main Screen 10
 - 4.2 User Access Levels 10
 - 4.2.1 Unlocking Access Levels 11
 - 4.2.2 Returning to the Locked Level 12
 - 4.3 Functions 13
 - 4.3.1 Select a Preset 13
 - 4.3.2 Setup/Change Data Log File 14
 - 4.3.3 View a Data Log File 15
 - 4.3.4 View Tool Information 16
 - 4.3.5 View Tool Statistics 16
 - 4.3.6 View Diagnostics 17
 - 4.3.7 Change the Set Torque 18
 - 4.3.8 Change the Set Angle 18
 - 4.3.9 Modify Presets 19
 - 4.3.10 Change the Torque Units 20
 - 4.3.11 Enable/Disable Angle Mode 20
 - 4.3.12 Enable/Disable Angle Lock 21
 - 4.3.13 Enable/Disable Reverse Target 21
 - 4.3.14 Enable/Disable Power-Up Lock 22
 - 4.3.15 Enable/Disable Increment 22
 - 4.3.16 Enable/Disable Reverse Confirmation 23
 - 4.3.17 Operator Password 23
 - 4.3.18 Maintenance Cycle Lock 25
 - 4.3.19 Maintenance Count Threshold 26
 - 4.3.20 Clear Maintenance Statistics 27
 - 4.3.21 Point Calibration 27
 - 4.3.22 Tool Calibration 29
 - 4.3.23 Low Pre-Torque 30



- 4.3.24 Factory Configurations 33
- 5.0 General Operating Instructions 33
 - 5.1 Reaction Arm 33
 - 5.1.1 Installing the Reaction Arm 33
 - 5.1.2 Reaction Arm Height 34
 - 5.1.3 Reaction Arm Foot 35
 - 5.1.4 Reaction Points 35
 - 5.2 Torque Only Operation..... 36
 - 5.3 Angle Only Operation 37
 - 5.4 Torque and Angle Operation 38
 - 5.4.1 Increment Disabled..... 38
 - 5.4.2 Increment Enabled 39
 - 5.5 Reviewing the Last Result..... 40
- 6.0 Data Log PC Operations 41
 - 6.1 Software Installation and PC Requirements 41
 - 6.2 Connecting E-RAD and PC 41
 - 6.3 Setting the Clock 43
 - 6.4 Downloading all Data Logs 43
 - 6.5 Deleting Data Logs from the E-RAD..... 44
 - 6.6 Exporting Data 44
 - 6.7 Uploading Operator Password File 45
- 7.0 Troubleshooting..... 46
 - 7.1 Error Messages..... 46
 - 7.1.1 Blank E-RAD Touch Display 47
 - 7.1.2 Fixed in Initialization Screen 47
 - 7.1.3 FB Not Ready/Analog Sensor 47
 - 7.1.4 Feedback Loss..... 47
 - 7.1.5 Overspeed 47
 - 7.1.6 Position Error 47
 - 7.1.7 Position Limit Exceeded..... 47
 - 7.1.8 Motor Stuck 47
 - 7.1.9 Peak Current Exceeded 47
 - 7.1.10 Inhibited 47
 - 7.1.11 Motor Cannot Start 47
 - 7.1.12 DB Inconsistent 48
 - 7.1.13 Under Voltage 48
 - 7.1.14 Over Voltage 48
 - 7.1.15 Short Circuit 48
 - 7.1.16 Over Temp..... 48
 - 7.1.17 "Internal Error" or "Program Error" 48
 - 7.1.18 "Watchdog Tripped" 48
 - 7.2 Solutions..... 48
 - 7.2.1 Power-Cycle 48
 - 7.2.2 AC Power Cable..... 49
 - 7.2.3 Tool Handle Motor and Feedback Cables..... 49
 - 7.2.4 AC Mains Power Supply..... 49
 - 7.2.5 Needs Cooling 49
 - 7.2.6 Forward/Reverse Switch..... 49
- 8.0 Contact Us 50



MANUAL REVISION HISTORY

Revision 2011.10.26: Initial Release for Firmware ERAD.25.0103

Revision 2012.03.02:

- Updated Section 6.0 – Data Log PC Operations
- Removed Reverse Torque Option until next firmware release
- Removed Serial Printer Option – Hardware no longer supported.

Revision 2012.04.26:

- ERAD25.0111 Firmware Release
- Updated PC Software Download Instructions

Revision 2012.11.20:

- ERAD25.0115 Firmware Release

Revision 2013.08.09:

- ERAD25.0117 Firmware Release

Revision 2014.07.04:

- ERAD25.0117 User Manual

Revision 2016.05.09:

- ERAD25.0117 Updated GFCI Guidelines



IMPORTANT SAFETY NOTICE

RAD TOOLS ARE SAFE AND RELIABLE. NOT FOLLOWING PRECAUTIONS AND INSTRUCTIONS OUTLINED HERE CAN RESULT IN INJURY TO THE TOOL, OPERATOR AND FELLOW WORKERS.

NEW WORLD TECHNOLOGIES INCORPORATED IS NOT RESPONSIBLE FOR ANY SUCH INJURY.

The intended use of the E-RAD Tool System is for commercial and industrial bolting applications.

Do not operate the E-RAD Tool System before reading and understanding this user manual and noting the Safety Notices displayed on the E-RAD Tool System and throughout this manual.

Only qualified personnel with training in the safe operation of torque tooling and the E-RAD Tool System should attempt the installation, operation and diagnosis of the E-RAD Tool System. The E-RAD Tool System is connected to high voltage power and consists of external rotating parts. Improper training and use can cause serious or fatal injury.

Do not disassemble or attempt to repair the E-RAD Tool System; doing so will void warranty. If breakdown, malfunction, or damage occurs and the E-RAD Tool System fails to operate correctly, contact New World Technologies Inc. Technical Support (refer to Section 8.0 – Contact Us).

The E-RAD Tool System should only be used if environmental storage and operation specifications have been met. Refer to Section 1.2.3 – Environmental Specifications.

Electrical Shock can cause serious or fatal injury. Do not apply power to the E-RAD Tool System without verifying the Earth Ground. Ensure the E-RAD Controller and Tool Handle are properly Earth Grounded before turning on the Power Switch. Do not touch any power devices or electrical connections or remove the E-RAD Controller Top Plate before ensuring the Power Switch is in the Off Position, the AC Mains Power has been disconnected and no high voltage is present.

Ensure all AC Mains Power wiring to the E-RAD AC Power Cable comply with all National and Local Electrical Codes. Improper wiring may result in unsafe conditions for equipment and personnel.

New World Technologies Inc. does not recommend replacing the supplied AC Power Cable. If using a different power cable or a power plug adapter, ensure the Earth Ground pin is present and firmly connected.

While operating the E-RAD Tool System, always wear safety goggles and keep all body parts clear of moving parts and the reaction arm contact point.

Always support the E-RAD Tool Handle while the E-RAD Tool System is in use. This will prevent unexpected release in the event of fastener or component failure.

Never exceed the Maximum Torque of the E-RAD Tool System. Failure to comply will result in void warranty.

The E-RAD Tool System has been calibrated by a qualified Calibration Technician; calibration must be done by a qualified Calibration Technician. Improper calibration can cause damage to the tool and joint.



1.0 General Information

1.1 System Components

The E-RAD Tool System is shipped from New World Technologies Inc. with the following parts:

- E-RAD Torque Tool Handle (Figure 1.1-1)
- E-RAD Touch Controller (Weatherproof (Figure 1.1-2) or Steel Case)
- AC Power Cable (Figure 1.1-3)
- Tool Handle Motor and Feedback Cables
- Standard Reaction Arm (Figure 1.1-4)
- Serial Communication Cable (USB A to B) – used for data retrieval
- Calibration Certificate
- User Manual



Figure 1.1-1: E-RAD Tool Handle



Figure 1.1-2: E-RAD Touch Controller



Figure 1.1-3: AC Power Cable

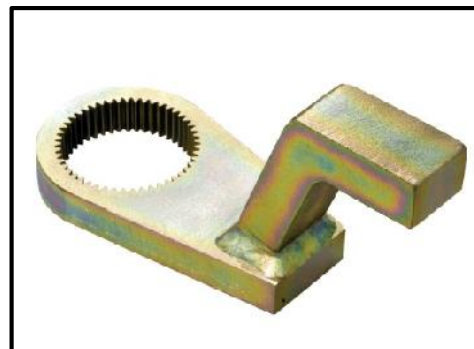

Figure 1.1-4: Standard Reaction Arm

Note: Some distributors may ship additional parts along with the E-RAD Tool System.

1.2 Specifications

1.2.1 Torque Ranges

The following table outlines the torque ranges, in Foot-Pounds and Newton-Meters, of each E-RAD Tool System:

E-RAD 700	100 – 700 FtLb	Or	135 – 950 Nm
E-RAD 1200	200 – 1200 FtLb	Or	270 – 1600 Nm
E-RAD 2000	250 – 2000 FtLb	Or	340 – 2700 Nm
E-RAD 2500 COMP	250 – 2500 FtLb	Or	340 – 3400 Nm
E-RAD 3000	500 – 3000 FtLb	Or	675 – 4050 Nm
E-RAD 4000	800 – 4000 FtLb	Or	1080 – 5400 Nm
E-RAD 6000	1500 – 6000 FtLb	Or	2030 – 8100 Nm

Table 1.2.1-1: Torque Ranges



1.2.2 Electrical Specifications

Ensure that all Electrical Specifications are followed when utilizing the E-RAD Tool System.

	Units	120V Model	230V Model
Nominal Input Frequency	Hz	50-60	
Nominal Input Voltage	VAC	120	208 - 240
Minimum Input Voltage	VAC	80% of Calibration Voltage	
Maximum Input Voltage	VAC	110% of Calibration Voltage	
Nominal Tool Voltage	VDC	160	328
Minimum Tool Voltage	VDC	80% of Calibration Voltage	
Maximum Tool Voltage	VDC	110% of Calibration Voltage	
Nominal Input Current	ARMS	5	5
Peak Tool Input Current	ARMS	15	15

Table 1.2.2-1: Electrical Specifications

E-RAD 120VAC TOOLS ARE CSA/UL CERTIFIED

E-RAD 230VAC TOOLS ARE CE CERTIFIED

1.2.3 Environmental Specifications

CAUTION!

Only operate the E-RAD Tool System if the following environmental storage and operation specifications have been met.

Ambient Operating Temperature Range	°C	°F
Minimum	-20	-4
Maximum	40	104
Storage Temperature Range	-25 to 70	-13 to 158
Humidity	10% to 90% non-condensing	
Area	No flammable gases or vapours permitted in area.	
Shock	10G according to DIN IEC 68-2-6/29	
Vibration	1G, 10-50Hz according to DIN IEC 68-2-6/69	

Table 1.2.3-1: Environmental Specifications

1.2.4 Cycle of Operation

A Cycle of Operation or a Tool Cycle is defined as:

- 10 seconds On
- 5 seconds Off

2.0 Power Requirements

The installer of this equipment is responsible for complying with National Electrical Code (NEC) or equivalent and Federal and Local Guidelines and Application Codes that govern protection, Earth Grounding, disconnects and other current protection for electrical equipment for use in outdoor or indoor applications.

The following sections outline the E-RAD power requirements.

2.1 AC Mains Power

DANGER!

Electrical Shock can cause serious or fatal injury. Do not apply power to the E-RAD Tool System without verifying the Earth Ground. Ensure the E-RAD Controller and Tool Handle are properly Earth Grounded before turning on the Power Switch. Do not touch any power device or electrical connection or remove the E-RAD Controller Top Plate before ensuring the Power Switch is in the Off Position, the AC Mains Power has been disconnected and no high voltage is present. New World Technologies Inc. does not recommend replacing the supplied AC Power Cable. If using a different power cable or a power plug adapter, ensure the Earth Ground pin is present and firmly connected.



WARNING!

Ensure all AC Mains wiring to the E-RAD AC Power Cable comply with all National and Local Electrical Codes. Improper wiring may result in unsafe conditions for equipment and personnel.

The E-RAD Controller requires model specific single phase 120VAC or 230VAC.

The single phase line must be electrically symmetrical with respect to Earth Ground. The branch circuit must be a dedicated 15A to ensure proper tool operation and to avoid circuit loading and nuisance trips.

Note: The E-RAD Controller is internally fused for self-protection. Contact New World Technologies Inc. Technical Support for assistance if a blown fuse is suspected.

2.2 Earth Grounding Safety

Important!

Earth Grounding is the primary electrical shock protection and is mandatory!

The E-RAD is assembled with a dedicated earth ground connection to the Tool Handle and Controller via the AC Mains Power Connection.

It is the operator's responsibility to adhere and follow, at minimum, an Assured Grounding Program and all National and Local Electrical Codes.

2.3 Ground Fault Current Interrupt (GFCI)

GFCI's are secondary protection devices which protect against electric shock in case of a ground wiring fault.

The E-RAD 2.5 Controller is compatible with Class A GFCI.

Note: National and Local Electrical Codes may require use of GFCI. Check National and Local Electrical Code for compliance.

2.4 Extension Cords

Extension cord quality and condition is important to ensure personal safety and E-RAD performance. Check National and Local Electrical Codes for compliance.

For extension cords under 30ft, 12AWG is recommended; for extension cords over 30ft, 10AWG is recommended.

Generally 100ft is the maximum recommended length for any extension cord, although some installations demand longer cords. Longer extension cords will reduce the voltage and speed of the E-RAD Tool System and may cause nuisance trips at higher torque demand.

2.5 Power Cycling

If AC power has been shut off from the E-RAD, it should not be reapplied for at least one minute. This allows the input surge protection to perform properly. Power cycling too quickly can cause nuisance trips and reduce the life-time of the electronics.

3.0 Tool System Assembly

CAUTION!

The E-RAD Controller and Tool Handle are calibrated as a system and are identified by the same serial number. It is important to always ensure the serial numbers match. If not, the tool will perform torque or angle operations in-accurately. This can cause equipment and joint failure due to under-torque or over-torque.

The following sections give a visual and functional description of the Tool Handle and Controller and instructions for connecting the Tool Handle, the Controller and the Power and Tool Handle Cables.

3.1 Tool Handle Description

The E-RAD Tool Handle (Figure 3.1-1) is trigger activated with a Forward/Reverse Switch. On each side of the tool housing is a LED Status Display (Figure 3.1-2) which notifies the



operator when the tool is ready for use, when the bolting cycle has passed or if the bolting cycle has failed.

1. Forward/Reverse Switch – controls direction of rotation.
2. On/Off Trigger – tool activation.
3. System Ready – blue LED will illuminate when the tool is ready for use.
4. Fail – red LED will illuminate when the tool fails to complete the torque cycle.
5. Pass – green LED will illuminate when the tool completes torque operation.



Figure 3.1-1: E-RAD Tool Handle

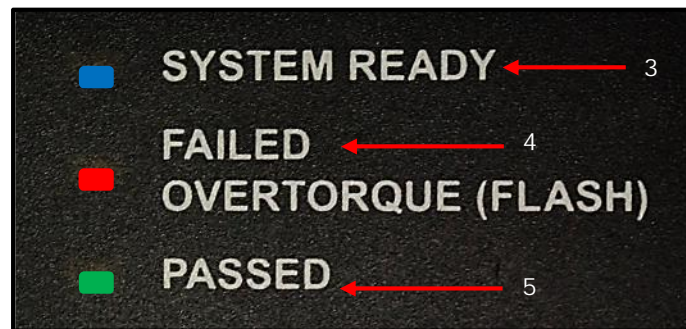

Figure 3.1-2: LED Status Display

3.2 Controller Description

The E-RAD Controller has a touch screen interface for ease of bolting operation and status, as well as advanced configuration options and Data Logging. The AC Power and Tool Handle Connections are located on the right side of the controller housing. Details are shown below in Figure 3.2-1 and Figure 3.2-2:

1. Feedback and Motor Power Connectors for the E-RAD Tool Handle.
2. AC Mains Input Power Connector (120V AC or 230V AC)
3. Serial Number for E-RAD Tool System (identical to Serial Number on Tool Handle)
4. Communication Port
5. LCD Touch Display
6. Power Switch



Figure 3.2-1: Controller Cable Connections



Figure 3.2-2: Controller Top Plate

3.3 Connecting the Tool Handle, the Controller and the Power

DANGER!

Electrical shock can cause serious or fatal injury. Ensure E-RAD Controller and Tool Handle are properly Earth Grounded before turning on the Power Switch. Do not turn on power to the Tool or operate the Tool without verifying the Earth Ground.

CAUTION!

Do not disconnect the electrical connectors while the E-RAD power is on. Damage to the Tool or Controller will occur.

By following the instructions below, the operator will safely connect the E-RAD Tool System. Once all these steps have been completed, the E-RAD Tool System will be ready to power on.

1. Refer to Section 2.0 – Power Requirements, and ensure compliance before connecting the Tool Handle or AC Power Cable to the Controller.
2. Ensure the Tool Handle and Controller Serial Numbers are identical.
3. Connect the Tool Handle Motor and Feedback Cables to the Motor Power and Feedback Connectors on the right side of the Controller.
4. Ensure the AC Mains Supply is Earth Grounded.
5. Ensure the AC Power Cable is in good condition; there are no cuts or breaks in the cable insulating jacket and the Plug Pins and Earth Ground Pin are present and in good condition.
6. Ensure the E-RAD Power Switch is in the Off Position.
7. Connect the E-RAD AC Power Cable to the AC Mains Input Power Connector on the right side of the Controller.
8. Connect the E-RAD AC Power Cable to the AC Mains Supply.
9. Check that the E-RAD Controller and Tool Handle are properly Earth Grounded.

4.0 Touch Display Interface

CAUTION!

LCD Touch Displays are susceptible to mechanical shock and any force exerted on the module may result in damage.

CAUTION!

LCD Touch Displays can be damaged by moisture or water and high temperatures. Avoid such conditions when storing and gently wipe clean or let dry before usage.



Note: Dirt from fingerprint oil can easily stain the surface of the display. Gently wipe off any stains with a soft, lint-free cloth.

The E-RAD Controller includes an LCD Touch Display. This simple touch screen interface has many functions, including Data Logging, Configuration Options and Torque and Angle Settings. The following sections describe these functions, as well as how to enable and/or use them.

4.1 Main Screen

The Main Screen is used as the central control point of the E-RAD Tool System. Here the operator can access: Menu Options, Presets, Torque and Angle Settings, and Data Logs. Figure 4.1-1 shows the Main Screen and indicated important aspects.

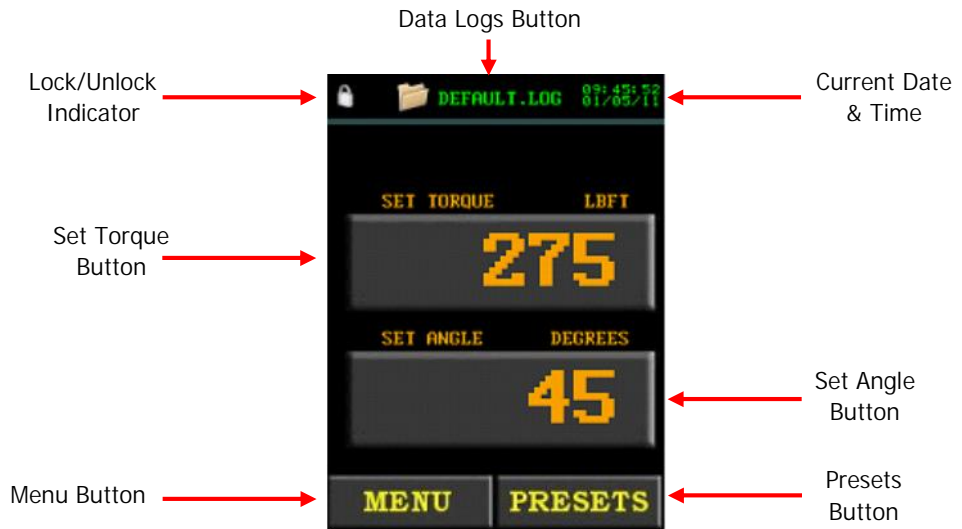

Figure 4.1-1: Main Screen

4.2 User Access Levels

Access to the functions on the Touch Display have been constricted to four Access Levels: the Locked Level, the Basic Level, the Intermediate Level and the Advanced Level. Access to the last three levels requires a password. Each level has a different password and access to different functions. Table 4.2-1 outlines the functions accessible to each level.



Function	Level			
	Locked	Basic	Intermediate	Advanced
Select a Preset	YES	YES	YES	YES
Setup a Data Log	YES	YES	YES	YES
View a Data Log	YES	YES	YES	YES
View Tool Information	YES	YES	YES	YES
View Tool Statistics	YES	YES	YES	YES
View Diagnostics	YES	YES	YES	YES
Modify Presets	NO	YES	YES	YES
Change Set Torque	NO	YES	YES	YES
Change Set Angle	NO	YES	YES	YES
Change Torque Units	NO	YES	YES	YES
Enable/Disable Angle Mode	NO	NO	YES	YES
Enable/Disable Angle Lock	NO	NO	YES	YES
Enable/Disable Reverse Target	NO	NO	YES	YES
Enable/Disable Power-Up Lock	NO	NO	YES	YES
Enable/Disable Increment	NO	NO	YES	YES
Enable/Disable Reverse Confirmation	NO	NO	YES	YES
Operator Password	NO	NO	YES	YES
Maintenance Cycle Lock	NO	NO	YES	YES
Maintenance Count Threshold	NO	NO	YES	YES
Clear Maintenance Statistics	NO	NO	YES	YES
Point Calibration	NO	NO	YES	YES
Tool Calibration	NO	NO	NO	YES
Low Pre-Torque	NO	NO	NO	YES
Factory Configurations	NO	NO	NO	YES

Table 4.2-1: User Access Levels and Functions

Note: The E-RAD Tool System is shipped from factory in the Basic Level. After configuration, it is recommended that the Tool be locked for normal bolting operations to avoid inadvertent changes to Tool Settings and Calibration.

4.2.1 Unlocking Access Levels

To unlock an Access Level:

1. Press the "Menu" button on the Main Screen.
2. Select the "Unlock" option from the Main Menu, shown in Figure 4.2.1-1. Result: A numeric keypad will be displayed as shown in Figure 4.2.1-2.



Figure 4.2.1-1: Main Menu



Figure 4.2.1-2: Numeric Keypad

3. Enter the password for the desired Access Level.
4. Press "ENT" to confirm the password or "CLR" to correct.



Result: If the password is invalid, an "INCORRECT" message will be displayed (Figure 4.2.1-3). If the password is correct, the display will return to the Main Screen and the desired Access Level will be unlocked (Figure 4.2.1-4).



Figure 4.2.1-3: Incorrect Password Message



Figure 4.2.1-4: Main Screen in the Basic, Intermediate or Advanced Level

Note: There is no longer a Lock Icon in the top left corner.

Access Level	Passcode
Basic	37232
Intermediate	Contact your RAD Distributer
Advanced	Contact your RAD Distributer

Table 4.2.1-1: Access Levels and Passwords

4.2.2 Returning to the Locked Level

To return to the Locked Access Level:

1. Press the "Menu" button on the Main Screen.
2. Select the "Lock" option from the Main Menu, shown in Figure 4.2.2-1. Result: A numeric keypad will be displayed as shown in Figure 4.2.2-2.



Figure 4.2.2-1: Main Menu



Figure 4.2.2-2: Numeric Keypad

3. Enter the password: 37232.
4. Press "ENT" to confirm the password or "CLR" to correct. Result: If the password is invalid, an "INCORRECT" message will be displayed (Figure 4.2.2-3). If the password is correct, the display will return to the Main Screen and the Touch Screen will have returned to the Locked Level (Figure 4.2.2-4).



Figure 4.2.2-3: Incorrect Password Message



Figure 4.2.2-4: Main Screen in the Locked Level

Note: The Lock Icon is now displayed in the top left corner.

4.3 Functions

The following sections describe the functions available on the E-RAD Touch Display Interface. Refer to Section 4.2 – User Access Levels for more information on the accessibility of these functions.

Note: When selecting an option from any menu, press the number to the left of the option.

Note: Menus many consist of several screens. To move through the menu, use the left and right arrow keys at the bottom of the screen.

Note: Menus will look different depending on the Access Level. The figures in this section are from the Advanced Access Level.

4.3.1 Select a Preset

A Preset is a pre-defined Set Torque and Set Angle value. They allow the operator to quickly and efficiently change the Set Torque and Set Angle.

To select a Preset:

1. Press the “Presets” button on the Main Screen.
2. Select “Load Preset” from the Preset Menu, shown in Figure 4.3.1-1.
3. Select the desired Preset from the list displayed. Figure 4.3.1-2 shows an example of the Load Preset Screen.



Figure 4.3.1-1: Preset Menu



Figure 4.3.1-2: Load Preset Screen



4.3.2 Setup/Change Data Log File

Note: When the E-RAD Tool System is turned on, the Data Log file name will be set to "DEFAULT.LOG". If the E-RAD is turned off during a desired Data Set, the Data Log file must be selected again when turned back on.

This function allows the operator to create and select Data Log files for recording and viewing different data sets.

To create a new data log file:

1. Press the Data Logs button (folder icon) located at the top of the Main Screen.
2. Select "Select Log" from the Data Log Menu, shown in Figure 4.3.2-1.
Result: The Select Log Screen will be displayed and the currently selected Log will be shown at the top of the screen and highlighted in the list of Data Logs (Figure 4.3.2-2).
3. Press the "New" button.
Result: An alpha-numeric keypad will be displayed as shown in Figure 4.3.2-3.

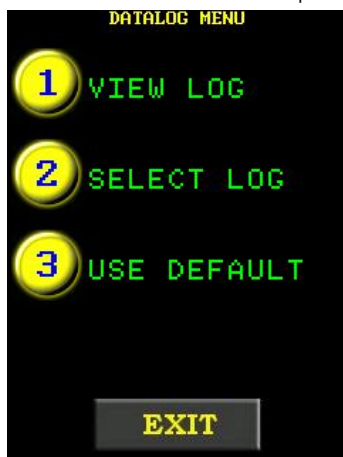

Figure 4.3.2-1: Data Log Menu



Figure 4.3.2-2: Select Log Screen



Figure 4.3.2-3: Alpha-Numeric Keypad

4. Enter the desired alpha-numeric file name using the displayed keypad.
Note: Press the key numerous times to cycle through the available characters on that key. The "1" key includes the characters "- " _ " ". If the operator pauses for more than one second, the cursor will move to the next position.
5. Press "ENT" to accept the file name or "CLR" to correct.
Result: If the Data Log file name already exists, the operator will be prompted to continue on the existing Log (Press "ENT") or choose another file name (Press "CLR"). This prompted window is shown in Figure 4.3.2-4.
Result: The new Data Log file name (or the continued existing one) will be displayed at the top of the Main Screen as shown in Figure 4.3.2-5.

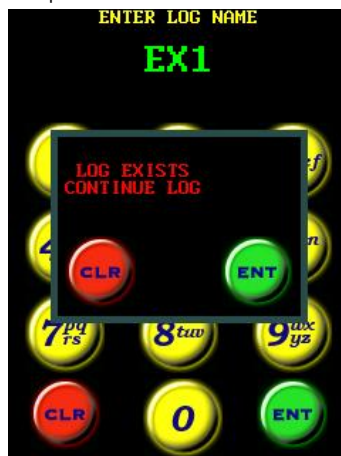



Figure 4.3.2-4: Data Log Already Exists Prompt

Figure 4.3.2-5: Main Screen with New Data Log Displayed

To select a different data log file:

1. Press the Data Logs button (folder icon) located at the top of the Main Screen.
2. Select "Select Log" from the Data Log Menu, shown in Figure 4.3.2-6.
Note: To use "DEFAULT.LOG", select "Use Default" from the Data Log Menu.
Result: The Select Log Screen will be displayed and the currently selected log will be shown at the top of the screen and highlighted in the List of Data Logs (Figure 4.3.2-7).

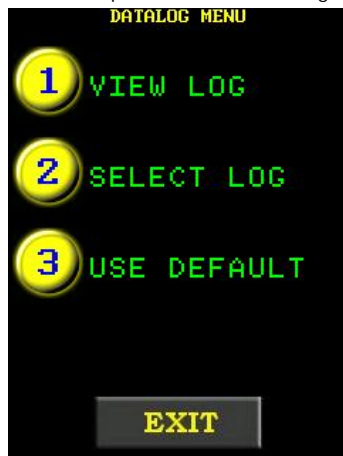

Figure 4.3.2-6: Data Log Menu

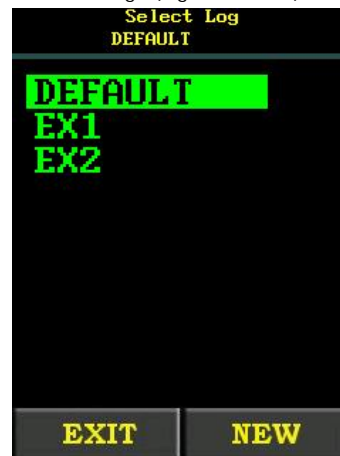

Figure 4.3.2-7: Select Log Screen

3. Select a Data Log.
Result: The Data Log will be shown at the top of the screen and highlighted in the List of Data Logs.
4. Press the "Exit" button.
Result: The display will return to the Data Log Menu.
5. Press the "Exit" button to return to the Main Screen.
Result: The Data Log file name will be displayed at the top of the Main Screen as shown in Figure 4.3.2-8.



Figure 4.3.2-8: Main Screen with New Data Log Displayed

4.3.3 View a Data Log File

This function allows the operator to view the data stored in the currently selected Data Log file. To select a different Data Log file, refer to Section 4.3.2 –Setup/Change Data Log File.

To view a data log file:

1. Press the Data Logs button (folder icon) located at the top of the Main screen.
2. Select "View Log" from the Data Log Menu, shown in Figure 4.3.3-1.
3. View individual Cycle Logs using the left and right arrow keys at the bottom of the screen.



Figure 4.3.3-1: Data Log Menu



Figure 4.3.3-2: View Cycle Logs – Passed Cycle



Figure 4.3.3-3: View Cycle Logs – Failed Cycle

Note: The text will be in green if the cycle passed (Figure 4.3.3-2) and in red if the cycle failed (Figure 4.3.3-3).

4. Press the “Exit” button to return to the Main Screen.

4.3.4 View Tool Information

This function allows the operator to view the following E-RAD Tool System information:

- E-RAD Serial Number
- Model Number
- Factory Calibration Date
- Customer Calibration Date (if Factory Calibration modified)
- Calibration Voltage
- Total Cycles
- Maintenance Cycles
- Minimum Torque
- Maximum Torque

To view the Tool Information:

1. Press the “Menu” button on the Main Screen.
2. Select “Tool Info” from the Main Menu, shown in Figure 4.3.4-1.
Result: The Tool Information Screen will be displayed for 20 seconds or until the “Exit” button is pressed. An example Tool Information Screen is shown in Figure 4.3.4-2.



Figure 4.3.4-1: Main Menu

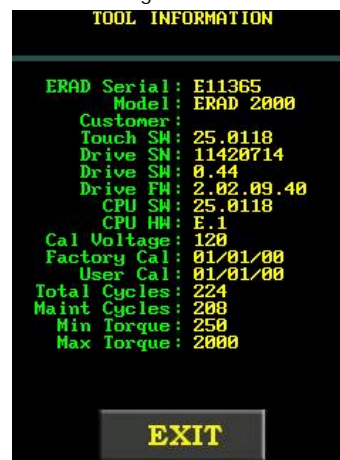

Figure 4.3.4-2: Tool Information Screen

4.3.5 View Tool Statistics

This function allows the operator to view the Life Statistics, Maintenance Statistics and Error Log for the E-RAD Tool System.



To view the Tool Statistics:

1. Press the "Menu" button on the Main Screen.
2. Select "Tool Stats" from the Main Menu, shown in Figure 4.3.5-1.
Result: The Tool Statistics Menu will be displayed (Figure 4.3.5-2). From here, the operator can select "Life Stats", "Maint Stats" or "Error Log".



Figure 4.3.5-1: Main Menu



Figure 4.3.5-2: Tool Statistics Menu

"Life Stats" displays all information since the tool was made (Figure 4.3.5-3).

"Maint Stats" displays all information since the last maintenance (Figure 4.3.5-4).

"Error Log" displays the last error and allows the operator to view individual errors using the left and right keys at the bottom of the screen.

Note: If an error has not occurred, the Error Log will say "No Errors" (Figure 4.3.5-5).

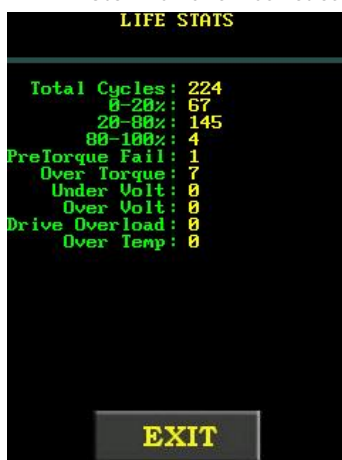

Figure 4.3.5-3: Life Statistics Screen

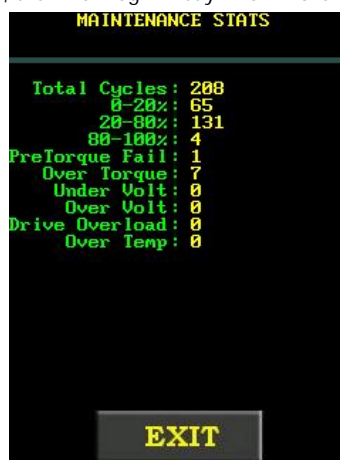

Figure 4.3.5-4: Maintenance Statistics Screen



Figure 4.3.5-5: Error Log Screen

4.3.6 View Diagnostics

This function displays information used when troubleshooting the E-RAD Tool System. This information includes Line Voltage, Drive Temperature, Motor Current, Motor Position, Peak Current, Minimum Voltage and Torque, as well as confirmation of the status of the On/Off Trigger, the Forward/Reverse Switch and each LED in the LED Status Display. Figure 4.3.6-1 shows the Diagnostics Display.

To view the Diagnostics Display:

1. Press the "Menu" button on the Main Screen.
2. Select "Diagnostics" from the Main Menu, shown in Figure 4.3.6-2.

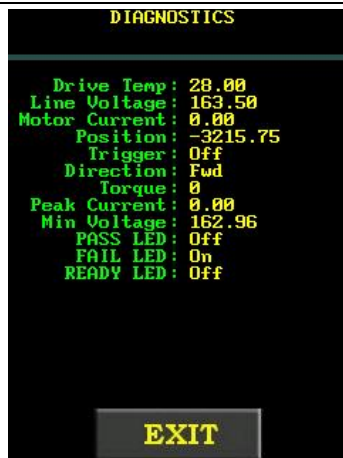

Figure 4.3.6-1: Diagnostics Display



Figure 4.3.6-2: Main Menu

Note: To return to the Main Screen, press the "Exit" button.

4.3.7 Change the Set Torque

This function allows the operator to change the Set Torque. The Set Torque is the torque value at which the E-RAD will stop the Torque Cycle and the cycle will be considered a pass. For more information on the Set Torque and Torque Cycle, refer to Section 5.2 – Torque Only Operation.

To change the Set Torque:

1. Press the "Set Torque" button on the Main Screen.
Result: A numeric keypad will be displayed as shown in Figure 4.3.7-1.
2. Enter the new Set Torque.
Note: Refer to Section 1.2.1 – Torque Ranges.
3. Press "ENT" to confirm the new Set Torque or "CLR" to correct.
Note: If the entered value is less than the Minimum Torque, it will be corrected to the Minimum Torque. If the entered value is greater than the Maximum Torque, it will be corrected to the Maximum Torque.
Result: The new Set Torque will be displayed on the Main Screen (Figure 4.3.7-2).



Figure 4.3.7-1: Numeric Keypad



Figure 4.3.7-2: Main Screen with New Set Torque

4.3.8 Change the Set Angle

This function allows the operator to change the Set Angle. The Set Angle is the angle value at which the E-RAD will stop the Angle Cycle and the cycle will be considered a pass. For more information on the Set Angle and Angle Cycle, refer to Section 5.3 – Angle Only Operation.

Note: To change the Set Angle, Angle Mode must be enabled, refer to Section 4.3.11 – Enable/Disable Angle Mode.



To change the Set Angle:

1. Press the "Set Angle" button on the Main Screen.
Result: A numeric keypad will be displayed as shown in Figure 4.3.8-1.
2. Enter the new Set Angle.
Note: The Set Angle range is 0 degrees and 10 to 360 degrees.
3. Press "ENT" to confirm the new Set Angle or "CLR" to correct.
Note: If the new Set Angle is less than 10 degrees and not 0 degrees, it will be corrected to 10 degrees. If the new Set Angle is greater than the maximum, the alert "Too High" will be displayed (Figure 4.3.8-2). Press "CLR" and the value will change to 360 degrees. The operator can now enter a different Set Angle or press "ENT" to accept 360 degrees.
Result: The new Set Angle will be displayed on the Main Screen as shown in Figure 4.3.8-3.



Figure 4.3.8-1: Numeric Keypad



Figure 4.3.8-2: Too High Alert



Figure 4.3.8-3: Main Screen with New Set Angle

4.3.9 Modify Presets

This function allows the operator to modify any of the eight Presets. Presets are pre-defined values of the Set Torque and the Set Angle. For more information on using Presets, refer to Section 4.3.1 – Select a Preset.

Note: If Angle Mode is disabled, the Presets will only consist of a Set Torque.

To modify a Preset:

1. Change the Set Torque and Set Angle to the desired values. Refer to Section 4.3.7 – Change the Set Torque and Section 4.3.8 – Change the Set Angle.
2. Press the "Presets" button on the Main Screen.
3. Select "Save Preset" from the Presets Menu, shown in Figure 4.3.9-1.
Result: The Load Preset Screen will be displayed, shown in Figure 4.3.9-2.
4. Select the desired Preset Number.
Note: The Set Torque and Set Angle values previously stored to the selected Preset Number will be overwritten.



Figure 4.3.9-1: Preset Menu



Figure 4.3.9-2: Load Preset Screen

4.3.10 Change the Torque Units

This function allows the operator to change the torque units to Foot-Pounds (FtLb), Newton-Meters (Nm) or Kilogram-Force-Meters (KgFm). When the units are changed, the Set Torque value, Preset Torque values and Calibration Values are automatically converted to the selected units.

To change the torque units:

1. Press the “Menu” button on the Main Screen.
2. Select “Change Units” from the Main Menu, shown in Figure 4.3.10-1.
3. Select the desired units from the unit options (Figure 4.3.10-2).



Figure 4.3.10-1: Main Menu



Figure 4.3.10-2: Units Menu

4.3.11 Enable/Disable Angle Mode

This function allows the operator to enable or disable the use of Angle Mode. When this function is enabled, the operator can change the Set Angle, modify and use Set Angle Preset values and operate in Angle Only and Torque and Angle Modes. Refer to Section 4.3.1 – Select a Preset, Section 4.3.8 – Change the Set Angle, Section 4.3.9 – Modify Presets, Section 5.3 – Angle Only Operation and Section 5.4 – Torque and Angle Operation.

To enable/disable Angle Mode:

1. Press the “Menu” button on the Main Screen.
2. Select “User Config” from the Main Menu, shown in Figure 4.3.11-1.
3. Select “Angle On” to enable Angle Mode or “Angle Off” to disable Angle Mode.
Note: When “Angle Off” is displayed, Angle Mode is currently enabled (Figure 4.3.11-2).

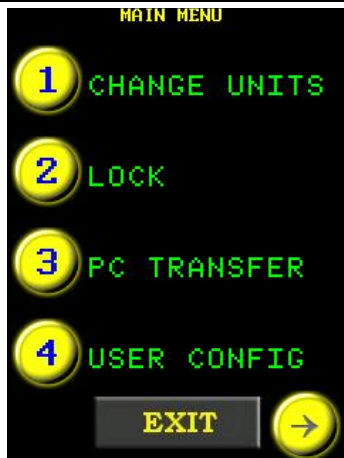

Figure 4.3.11-1: Main Menu



Figure 4.3.11-2: User Configuration Menu

4.3.12 Enable/Disable Angle Lock

WARNING!

Injury to the operator and damage to the E-RAD may occur during an Angle Locked Cycle. Close attention is required during a cycle to prevent such injury and damage. To stop the Angle Locked Cycle, switch the Forward/Reverse Switch to the Reverse Position.

This function allows the operator to release the On/Off Trigger during an Angle Only Cycle or a Torque and Angle Cycle. The cycle will continue until it has passed.

To stop the Angle Locked Cycle at any time, switch the Forward/Reverse Switch to the Reverse Position. This will result in a failed cycle.

To pause the Angle Locked Cycle, press the On/Off Trigger. This will pause the cycle. To continue the Angle Locked Cycle, press the On/Off Trigger.

To enable/disable the Angle Lock:

1. Press the "Menu" button on the Main Screen.
2. Select "User Config" from the Main Menu, shown in Figure 4.3.12-1.
3. Select "Ang. Lock On" to enable Angle Lock or "Ang. Lock Off" to disable Angle Lock.

Note: When "Ang. Lock Off" is displayed, the Angle Lock is enabled (Figure 4.3.12-2).

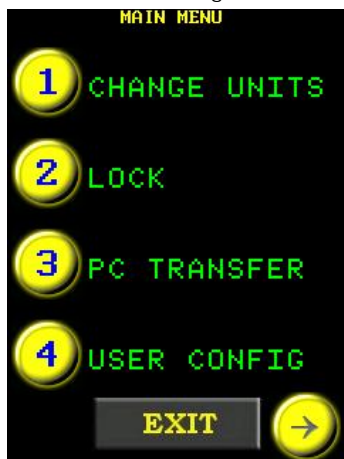

Figure 4.3.12-1: Main Menu



Figure 4.3.12-2: User Configuration Menu

4.3.13 Enable/Disable Reverse Target

When this function is enabled, the operator can enter a Target Torque for the reverse cycle. The E-RAD Tool System will reverse until the Actual Torque reaches the Target Torque. This is similar to a regular Torque Cycle, but in the reverse direction.



To enable/disable Reverse Target:

1. Press the "Menu" button on the Main Screen.
2. Select "User Config" from the Main Menu, shown in Figure 4.3.13-1.
3. Select "REV TARG ON" to enable the Reverse Target or "REV TARG Off" to disable the Reverse Target.

Note: When "REV TARG OFF" is displayed, the Reverse Target is enabled (Figure 4.3.13-2).

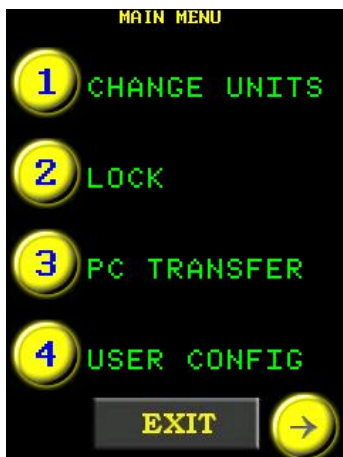

Figure 4.3.13-1: Main Menu



Figure 4.3.13-2: User Configuration Menu

4.3.14 Enable/Disable Power-Up Lock

When this function is enabled, upon power-up, the E-RAD Touch Display will be in the Locked Access Level, regardless of the previous state.

To enable/disable Power-Up Lock:

4. Press the "Menu" button on the Main Screen.
5. Select "User Config" from the Main Menu, shown in Figure 4.3.14-1.
6. Select "PUP Lock On" to enable the Power-Up Lock or "PUP Lock Off" to disable the Power-Up Lock.

Note: When "PUP Lock Off" is displayed, the Power-Up Lock is enabled (Figure 4.3.14-2).

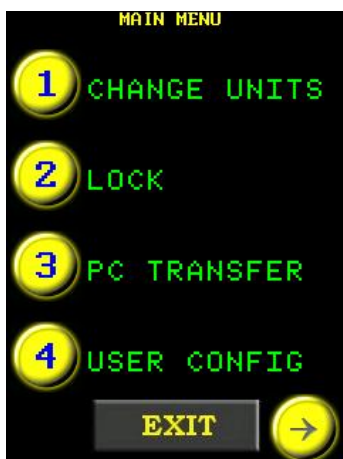

Figure 4.3.14-1: Main Menu



Figure 4.3.14-2: User Configuration Menu

4.3.15 Enable/Disable Increment

This function changes the way the Torque and Angle Operation works. Refer to Section 5.4 – Torque and Angle Operation for more information.

To enable/disable Increment:

1. Press the "Menu" button on the Main Screen.
2. Select "User Config" from the Main Menu, shown in Figure 4.3.15-1.



3. Select "Increment On" to enable Increment or "Increment Off" to disable Increment.

Note: When "Increment Off" is displayed, Increment is enabled (Figure 4.3.15-2).

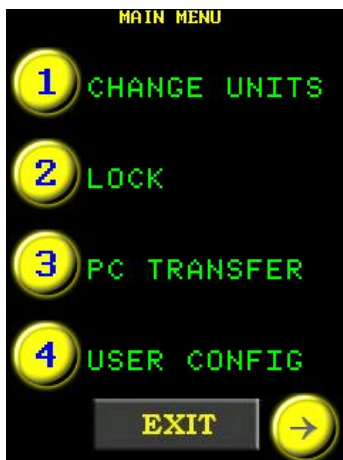

Figure 4.3.15-1: Main Menu



Figure 4.3.15-2: User Configuration Menu

4.3.16 Enable/Disable Reverse Confirmation

This function prevents the operator from reversing without acknowledgement. While this function is enabled, the Touch Display will prompt the operator to confirm the use of the reverse setting.

To enable/disable Reverse Confirmation:

1. Press the "Menu" button on the Main Screen.
2. Select "User Config" from the Main Menu, shown in Figure 4.3.16-1.
3. Select "RVS CONF ON" to enable Reverse Confirmation or "RVS CONF OFF" to disable Reverse Confirmation.

Note: When "RVS CONF OFF" is displayed, Reverse Confirmation is enabled, Figure 4.3.16-2.

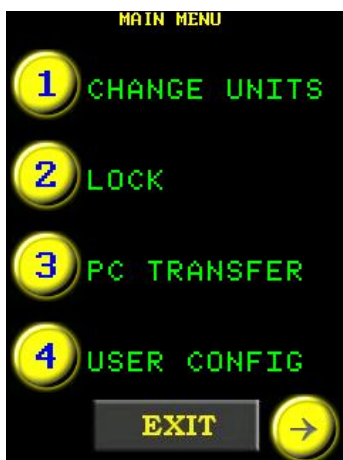

Figure 4.3.16-1: Main Menu



Figure 4.3.16-2: User Configuration Menu

4.3.17 Operator Password

While enabled, this function will disable the operation of the E-RAD Tool System until the operator logs in using one of the passwords in the Operator Password File uploaded to the E-RAD (refer to Section 6.7 – Uploading Operator Password File). The operator will still have full access to the Main Menu and all functions accessible from there. The display will not exit from the Main Menu, preventing the operator from accessing the Presets, Set Torque, Set Angle and Data Logs and from operating the E-RAD Tool Handle



For instructions on creating an Operator Password File, refer to Section 6.7 – Uploading Operator Password File.

To enable/disable the Operator Password:

1. Press the “Menu” button on the Main Screen.
2. Select “User Config” from the Main Menu, shown in Figure 4.3.17-1.
3. Select “OP P/W On” to enable the Operator Password or “OP P/W Off” to disable the Operator Password.

Note: When “OP P/W Off” is displayed, the Operator Password is enabled (Figure 4.3.17-2).

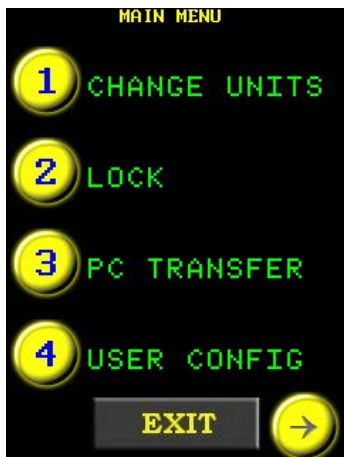

Figure 4.3.17-1: Main Menu



Figure 4.3.17-2: User Configuration Menu

To login:

Note: When the Operator Password function is enabled, the display will return to the Main Menu Screen and the “Login” option will be displayed.

1. Select “Login” from the Main Menu, shown in Figure 4.3.17-3.

Note: An alpha-numeric keypad will be displayed (Figure 4.3.17-4).

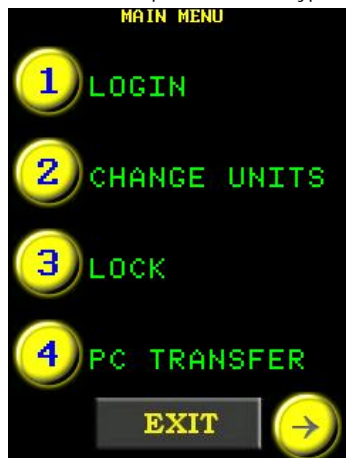

Figure 4.3.17-3: Main Menu



Figure 4.3.17-4: Alpha-Numeric Keypad

2. Enter an Operator Password.
Note: If an Operator Password File has not been uploaded to the E-RAD, any password can be used to login.
3. Press “ENT” to confirm or “CLR” to correct.
Result: The display will return to the Main Menu and the “Logout” option will be displayed (Figure 4.3.17-5).

To logout:

1. Press the “Menu” button on the Main Screen.
2. Select “Logout” from the Main Menu, shown in Figure 4.3.17-6.



Result: The display will return to the Main Menu and the "Login" option will be displayed (Figure 4.3.17-7).

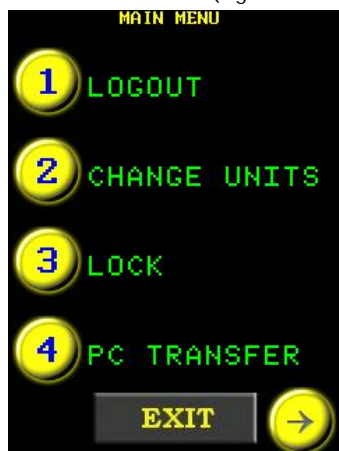

Figure 4.3.17-5: Main Menu with Logout Option

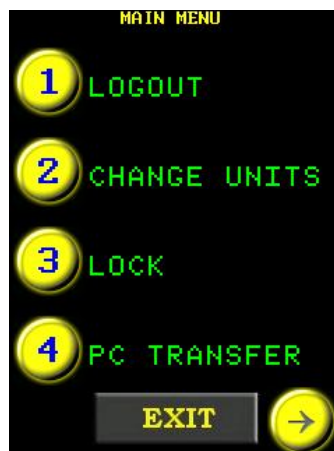

Figure 4.3.17-6: Main Menu

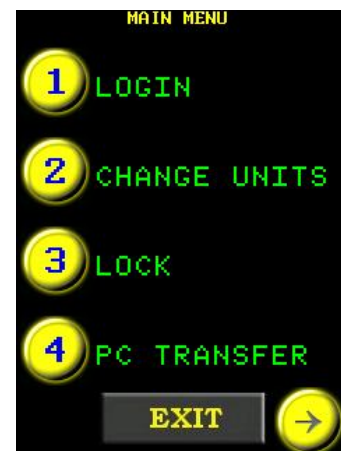

Figure 4.3.17-7: Main Menu with Login Option

4.3.18 Maintenance Cycle Lock

When enabled, this function will disable the E-RAD after an operator defined number of cycles is reached. When the operator enables this function, the desired number of Warning Cycles and Shut-off Cycles must be entered. When the number of cycles defined as Warning Cycles is reached, the operator will be advised how many cycles remain before the Tool is disabled. Note: Reverse Cycles are counted as well as Forward Cycles.

To enable/disable the Maintenance Cycle Lock:

1. Press the "Menu" button on the Main Screen.
2. Select "User Config" from the Main Menu, shown in Figure 4.3.18-1.
3. Select "CYC Lock On" to enable the Maintenance Cycle Lock or "CYC Lock Off" to disable the Maintenance Cycle Lock.

Note: When "CYC Lock Off" is displayed, the Maintenance Cycle Lock is enabled (Figure 4.3.18-2).

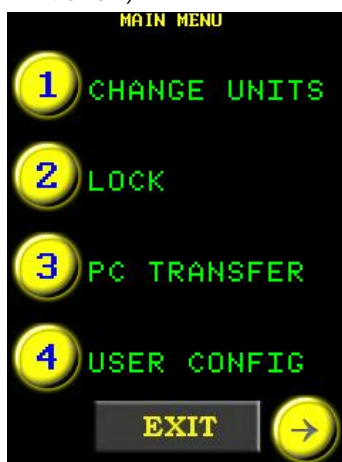

Figure 4.3.18-1: Main Menu



Figure 4.3.18-2: User Configuration Menu

To set the Warning Cycles and the Shut-Off Cycles:

Note: To set the Warning Cycles and Shut-Off Cycles, the Maintenance Cycle Lock must be enabled.

1. Press the "Menu" button on the Main Screen.
2. Select "User Config" from the Main Menu, shown in Figure 4.3.18-3.
3. Select "Cycle Warn" from the User Configuration Menu, shown in Figure 4.3.18-4. Result: A numeric keypad will be displayed (Figure 4.3.18-5).

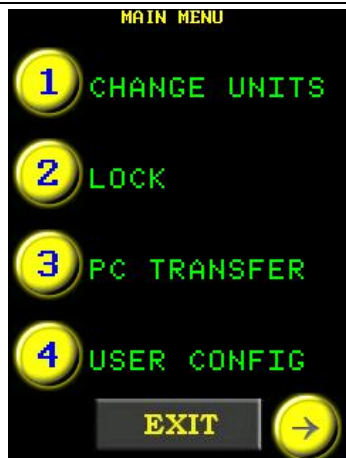

Figure 4.3.18-3: Main Menu



Figure 4.3.18-4: User Configuration Menu

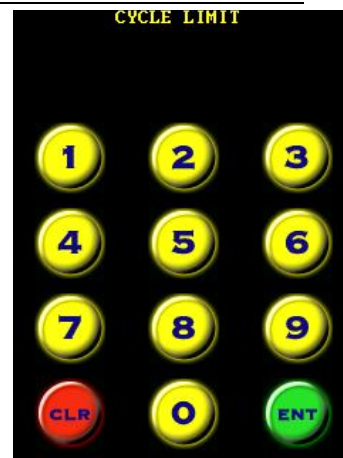

Figure 4.3.18-5: Numeric Keypad

4. Enter the desired number of cycles before the operator is advised of the number of cycles remaining before the E-RAD is disabled for maintenance.
5. Press "ENT" to confirm the Warning Cycles or "CLR" to correct.
Result: The display will return to the Main Screen.
6. Press the "Menu" button on the Main Screen.
7. Select "User Config" from the Main Menu, shown in Figure 4.3.18-6.
8. Select "Cycle Limit" from the User Configuration Menu, shown in Figure 4.3.18-7.
Result: A numeric keypad will be displayed (Figure 4.3.18-8).
9. Enter the desired number of cycles before the E-RAD is disabled for maintenance.
10. Press "ENT" to confirm the Shut-Off Cycles or "CLR" to correct.
Result: The display will return to the Main Screen.

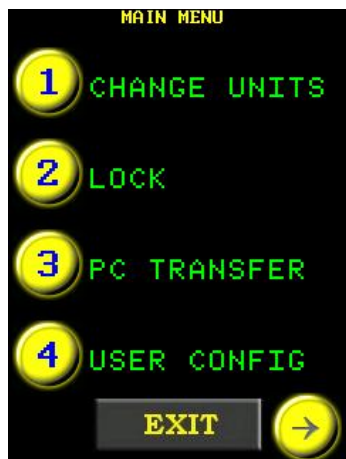

Figure 4.3.18-6: Main Menu



Figure 4.3.18-7: User Configuration Menu



Figure 4.3.18-8: Numeric Keypad

4.3.19 Maintenance Count Threshold

This function restricts the cycles counted toward the Warning Cycles and the Shut-Off Cycles referred to in Section 4.3.18 – Maintenance Cycle Lock. The operator sets a desired torque threshold and only cycles with a greater Set Torque than this threshold are counted.

Note: This function is especially useful in tandem with the Maintenance Cycle Lock. Refer to Section 4.3.18 – Maintenance Cycle Lock for more information.

Note: Reverse Cycles with a torque greater than the Threshold Torque will be counted.

To set the Maintenance Count Threshold:

1. Press the "Menu" button on the Main Screen.
2. Select "User Config" from the Main Menu, shown in Figure 4.3.19-1.



3. Select "Maint PCT TRQ" from the User Configuration Menu, shown in Figure 4.3.19-2.

Result: A numeric keypad will be displayed (Figure 4.3.19-3).

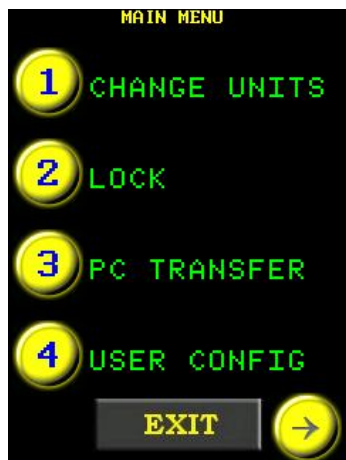

Figure 4.3.19-1: Main Menu

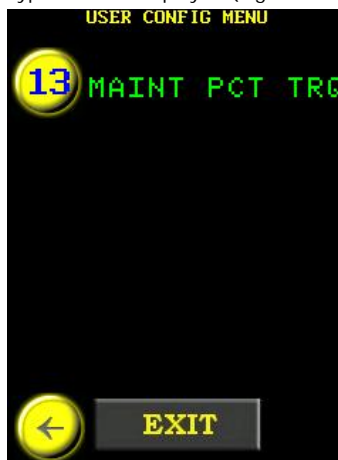

Figure 4.3.19-2: User Configuration Menu



Figure 4.3.19-3: Numeric Keypad

4. Enter the desired Minimum Torque Threshold in percent of the E-RAD's full scale.
Note: The number entered is the desired Minimum Torque Threshold divided by the Maximum Torque of the E-RAD Tool System multiplied by 100%.

$$= \frac{\text{minimum torque threshold}}{\text{maximum torque of E RAD}} \times 100\%$$

4.3.20 Clear Maintenance Statistics

This function allows the operator to clear the Maintenance Statistics. This is generally done after maintenance. To view the Maintenance Statistics, refer to Section 4.3.5 – View Tool Statistics.

To clear Maintenance Statistics:

1. Press the "Menu" button on the Main Screen.
2. Select "Tool Stats" from the Main Menu, shown in Figure 4.3.20-1.
3. Select "Clear Maint" from the Statistics Menu, shown in Figure 4.3.20-2.
4. Select "Confirm CLR" to confirm the clearing of the Maintenance Statistics or press the "Exit" button to cancel (Figure 4.3.20-3).



Figure 4.3.20-1: Main Menu



Figure 4.3.20-2: Statistics Menu

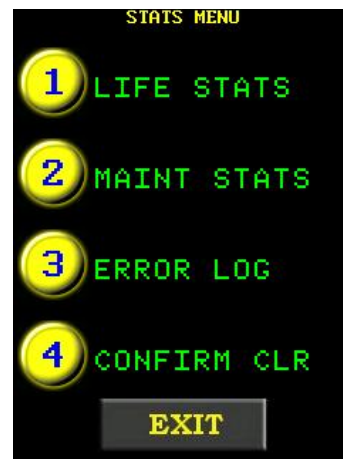

Figure 4.3.20-3: Statistics Menu with Confirm CLR Option

4.3.21 Point Calibration

WARNING!

Only qualified personnel with training in the safe operation of torque tooling and the E-RAD Tool System should operate this tool.



This function allows the operator to quickly adjust the Calibration for a specific Set Torque. Point Calibration is useful in field applications when the torque needs to be verified and adjusted. This adjustment is only valid when the Point Calibration is enabled and for the specific Set Torque. If the Set Torque is changed while still in Point Calibration Mode, the operator will be prompted to recalibrate for the new Set Torque.

Note: Point Calibration does not overwrite the E-RAD Tool Calibration. For information on Tool Calibration, refer to Section 4.3.22 – Tool Calibration.

To enable/disable Point Calibration:

1. Press the "Menu" button on the Main Screen.
2. Select "User Config" from the Main Menu, shown in Figure 4.3.21-1.
3. Select "Point Cal On" to enable Point Calibration or "Point Cal Off" to disable Point Calibration (Figure 4.3.21-2).

Result: The display will return to the Main Screen. If Point Calibration is enabled, a target icon will appear at the top of the Main Screen (Figure 4.3.21-3).

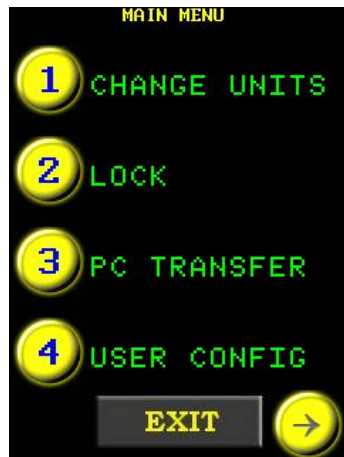

Figure 4.3.21-1: Main Menu

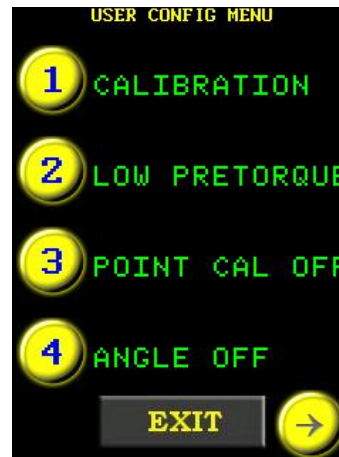

Figure 4.3.21-2: User Configuration Menu



Figure 4.3.21-3: Main Screen in Point Calibration Mode

To configure Point Calibration:

Note: A Calibration Stand is needed to perform this procedure.

1. Ensure Point Calibration is enabled.
2. Mount E-RAD to the Calibration Stand.
3. Ensure the Calibration Transducer is set to the same units as the E-RAD Tool System.
4. Ensure the E-RAD is in Torque Only Mode. Refer to Section 5.2 – Torque Only Operation.
5. Press the "Set Torque" button on the Main Screen.
Result: A numeric keypad will be displayed (Figure 4.3.21-4).
6. Enter the desired Target Torque.

Note: Press "ENT" to confirm torque or "CLR" to correct.

Result: A numeric keypad will be displayed along with a prompt to enter the Measured Torque 1 (Figure 4.3.21-5).

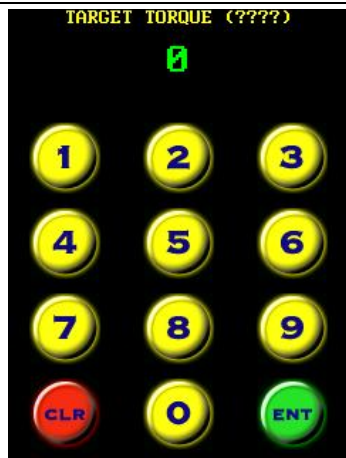

Figure 4.3.21-4: Numeric Keypad

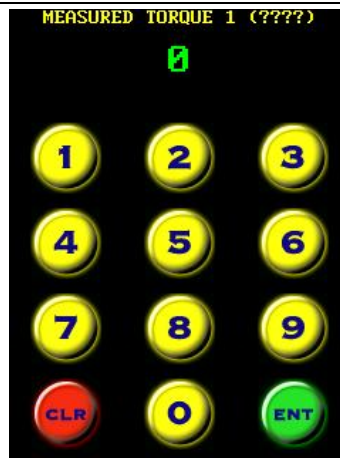

Figure 4.3.21-5: Numeric Keypad

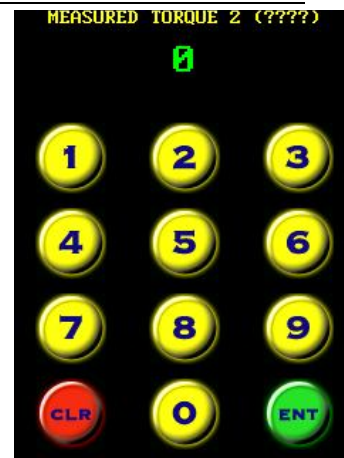

Figure 4.3.21-6: Numeric Keypad

7. Operate the E-RAD through one pass cycle.
8. Enter the torque measured by the Calibration Transducer.
Note: Press "ENT" to confirm torque or "CLR" to correct.
Result: A numeric keypad will be displayed along with a prompt to enter the Measured Torque 2 (Figure 4.3.21-6).
9. Operate the E-RAD through one pass cycle.
10. Enter the torque measured by the Calibration Transducer.
Note: Press "ENT" to confirm torque or "CLR" to correct.
Result: The Main Screen will be displayed and the Point Calibration Adjustment will be saved.
Result: The torque will be adjusted by the Point Calibration for the Target Torque entered in Step 5 until a new torque is entered or Point Calibration is disabled.

4.3.22 Tool Calibration

WARNING!

Only qualified personnel with training in the safe operation of torque tooling and the E-RAD Tool System should operate this tool.

CAUTION!

Do not calibrate at Set Torques that result in exceeding the E-RAD Tool System's Torque Range. Severe tool damage will occur.

This function provides access to the Calibration Values for the full Torque Range of the E-RAD Tool System. Calibration Values should only be modified by a Qualified Calibration Technician and with the use of a Calibration Stand.

The Calibration Values represent a relationship between the Actual Output Torque of the E-RAD Tool System and the Set Torque. By changing the Calibration Values, the E-RAD is more accurate and precise.

Note: When the Calibration Values are modified by the operator, the date is stored as the Customer Calibration Date in the Tool Information. When the Calibration Values are modified by a New World Technologies Inc. Calibration Technician, the date is stored as the Factory Calibration Date in the Tool Information. Refer to Section 4.3.4 – View Tool Information.

To calibrate the E-RAD Tool System:

1. Ensure the E-RAD is in Torque Only Mode. Refer to Section 5.2 – Torque Only Operation.
2. Press the "Menu" button on the Main Screen.
3. Select "User Config" from the Main Menu, shown in Figure 4.3.22-1.
4. Select "Calibration" from the User Configuration Menu, shown in Figure 4.3.22-2.
Result: A prompt screen will be displayed asking to confirm the Calibration or cancel the Calibration (Figure 4.3.22-3).

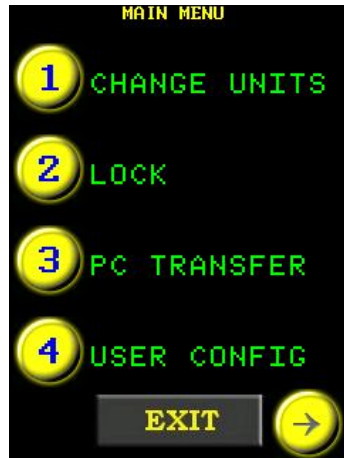

Figure 4.3.22-1: Main Menu



Figure 4.3.22-2: User Configuration Menu



Figure 4.3.22-3: Confirm Calibration Prompt

5. Press the "ENT" button to enter Calibration.
Result: The 7% Calibration screen will be displayed (Figure 4.3.22-4).
6. Mount E-RAD to the Calibration Stand.
7. Ensure the Calibration Transducer is set to the same units as the E-RAD Tool System
8. Do one Torque Cycle.
9. Press the "Cal Value" button on the Calibration Screen (Figure 4.3.22-4).
Result: A numeric keypad will be displayed (Figure 4.3.22-5).
10. Enter the torque measured by the Transducer.
11. Press "ENT" to confirm or "CLR" to correct.
Result: The next Calibration Screen will be displayed.



Figure 4.3.22-4: 7% Calibration Screen

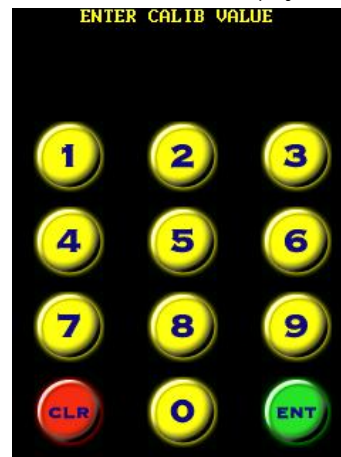

Figure 4.3.22-5: Numeric Keypad



Figure 4.3.22-6: Save Calibration Prompt

12. Repeat steps 8 to 11 for each torque percentage.
13. Press the "Exit" button.
Result: The operator will be prompted to save before exiting (Figure 4.3.22-6).
14. Press "ENT" to save and exit or "CLR" to not save and exit.
Result: The display will return to the Main Screen.

4.3.23 Low Pre-Torque

This function allows the operator to select from and modify three Low Pre-Torques which are below the Minimum Torque of the E-RAD Tool System. For more information on Pre-Torque and when it occurs, refer to Section 5.3 – Angle Only Operation and Section 5.4 – Torque and Angle Operation.

Note: Angle Mode must be enabled to access and use Low Pre-Torque. Refer to Section 4.3.11 – Enable/Disable Angle Mode.



To select a Low Pre-Torque:

1. Press the “Menu” button on the Main screen.
2. Select “User Config” from the Main Menu, shown in Figure 4.3.23-1.
3. Select “Low Pretorque” from the User Configuration Menu, shown in Figure 4.3.23-2.

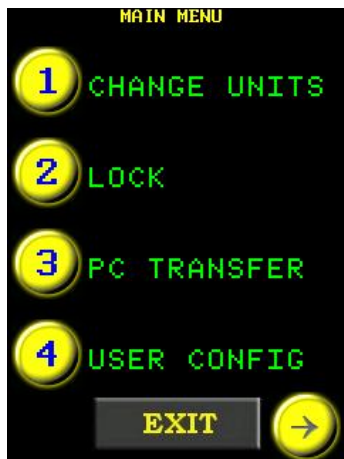

Figure 4.3.23-1: Main Menu

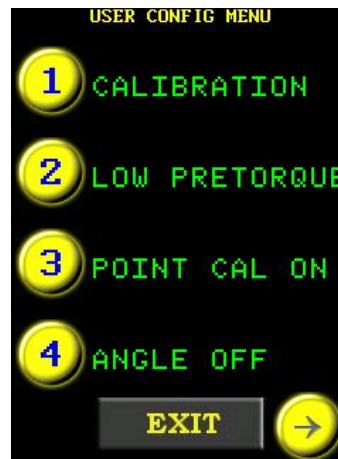

Figure 4.3.23-2: User Configuration Menu

4. Select one of the Preset Pre-Torques from the Low Pre-Torque Menu (Figure 4.3.23-3).

Result: Low Pre-Torque Adjustment Screen will be displayed (Figure 4.3.23-4).



Figure 4.3.23-3: Low Pre-Torque Menu



Figure 4.3.23-4: Low Pre-Torque Adjustment Screen

5. Press the “Exit” button at the bottom of the screen.
Result: The display will return to the Low Pre-Torque Menu and the selected Low Pre-Torque will be enabled.
6. Press the “Exit” button at the bottom of the screen to return to the Main Screen.

To modify a Low Pre-Torque:

1. Press the “Menu” button on the Main Screen.
2. Select “User Config” from the Main Menu, shown in Figure 4.3.23-5.
3. Select “Low Pretorque” from the User Configuration Menu, Figure 4.3.23-6.
4. Select the Low Torque from the Low Pre-Torque Menu (Figure 4.3.23-7).

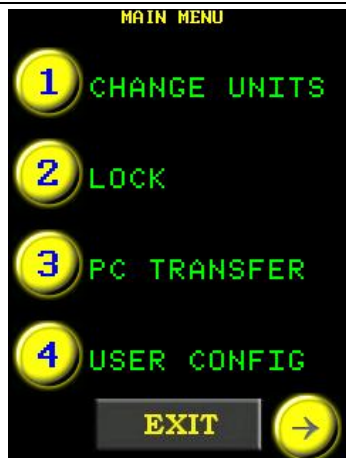

Figure 4.3.22-5: Main Menu



Figure 4.3.23-6: User Configuration Menu



Figure 4.3.23-7: Low Pre-Torque Menu

Result: The Low Pre-Torque Adjustment Screen will be displayed. An example of this screen is shown in Figure 4.3.23-8.

- 5. Press the "Torque Value" button on the Low Pre-Torque Adjustment Screen.

Result: A numeric keypad will be displayed (Figure 4.3.23-9).



Figure 4.3.23-8: Low Pre-Torque Adjustment Screen

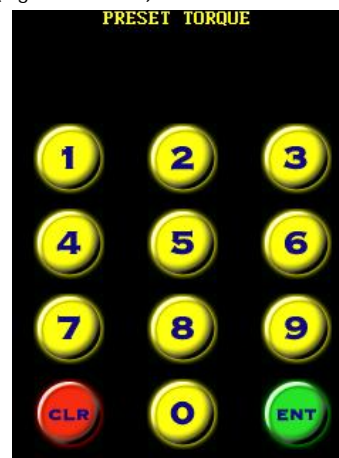

Figure 4.3.23-9: Numeric Keypad

- 6. Enter the Torque Value.
- 7. Press "ENT" to confirm or "CLR" to correct.
- 8. Mount E-RAD to the Calibration Stand and ensure the Calibration Transducer is set to the same units as the E-RAD Tool System
- 9. Do one Pre-Torque Cycle.
- 10. Calculate the Adjustment Value using the torque measured by the Transducer. Use the following equation:

$$\text{Adjustment Value} = \frac{\text{PreTorque Value}}{\text{Transducer Torque}} \times 1000$$

- 11. Press the "Adjustment" button on the Low Pre-Torque Adjustment Screen, shown in Figure 4.3.23-8.

Result: A numeric keypad will be displayed (Figure 4.3.23-10).

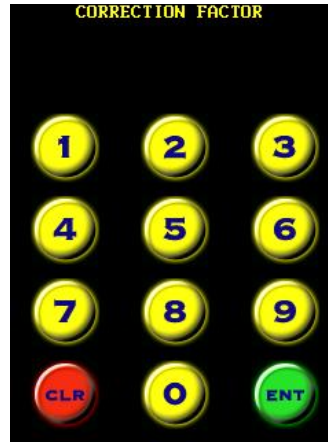

Figure 4.3.23-10: Numeric Keypad

12. Enter the Adjustment Value.
13. Press "ENT" to confirm or "CLR" to correct.
14. Press the "Exit" button at the bottom of the screen.
Result: The display will return to the Low Pre-Torque Menu and the modifications will be saved.
15. Press the "Exit" button at the bottom of the screen to return to the Main Screen.

4.3.24 Factory Configurations

This function is used to adjust factory settings including Minimum Torque, Maximum Torque, Angle Mode and Gear Ratio. These settings should only be used under the direction of New World Technologies Inc. Technical Support.

Note: Contact New World Technologies Inc. Technical Support for more information (refer to Section 8.0 – Contact Us).

5.0 General Operating Instructions

WARNING!

Only qualified personnel with training in the safe operation of torque tooling and the E-RAD Tool System should operate this tool.

There are three ways to operate the E-RAD Tool System, using Torque Only, Angle Only or Torque and Angle. Each of these operations, the use of the Reaction Arm and reviewing the Last Result are discussed in the following sections.

5.1 Reaction Arm

WARNING!

Always keep body parts clear of the Reaction Arm when the E-RAD Tool System is in use. Serious injury could occur.

CAUTION!

Ensure the Reaction Arm has a solid contact point before operating the E-RAD Tool System.

5.1.1 Installing the Reaction Arm

Ensure the Reaction Arm and Snap Ring are installed securely to hold the Reaction Arm in place. Make sure the Reaction Arm is in contact with a solid Reaction Point before you operate the tool. Keep your body parts clear of the Reaction Arm when the tool is in operation.

When the tool is in operation the Reaction Arm rotates in the opposite direction to the Output Square Drive and must be allowed to rest squarely against a solid object or surface adjacent to the bolt to be tightened (Figure 5.1.1-1).

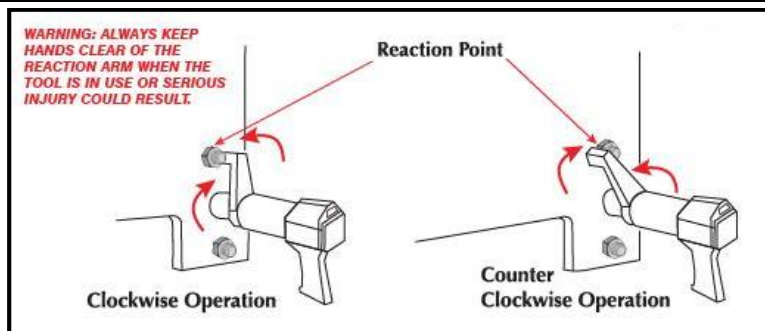

Figure 5.1.1-1 – Reaction Arm Rotation

CAUTION!

Keep your hand and body parts clear of the Reaction Arm and barrel when the tool is in operation.



Figure 5.1.1-2: Incorrect Placement of Hand/Body Parts During Operation

5.1.2 Reaction Arm Height

Ensure the height of the socket is even with the height of the Reaction Arm as seen below in Figure 5.1.2-1. The height of the socket cannot be shorter or higher than the height of the Reaction Arm as seen below in Figure 5.1.2-2.

CORRECT: The Reaction Arm and socket are even height.

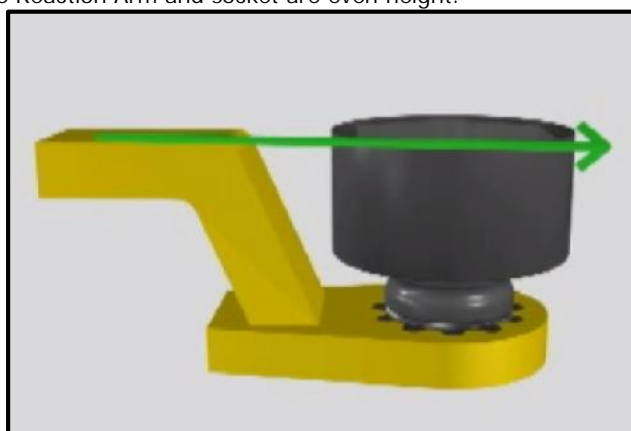

Figure 5.1.2-1: Correct Height



INCORRECT: The leg of the Reaction Arm is too short on the left side, and too long on the right side.

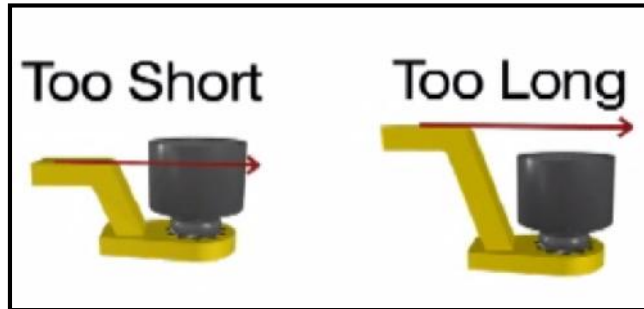

Figure 5.1.2-2: Incorrect Height

IMPROPER REACTION WILL VOID WARRANTY AND CAN CAUSE PREMATURE TOOL FAILURE.

5.1.3 Reaction Arm Foot

Ensure the foot of the Reaction Arm aligns with the length of the nut as seen in Figure 5.1.3-1. The length of the foot cannot be shorter or longer than the nut as seen in Figure 5.1.3-2.

CORRECT: The foot of the Reaction Arm aligns with the length of the nut.

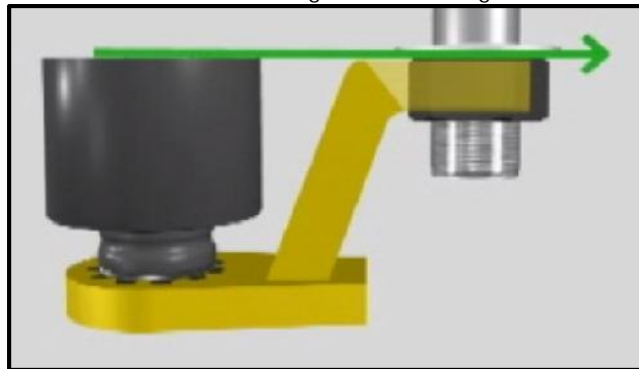

Figure 5.1.3-1: Correct Length

INCORRECT: The foot of the Reaction Arm is too short on the left side, and too long on the right side.

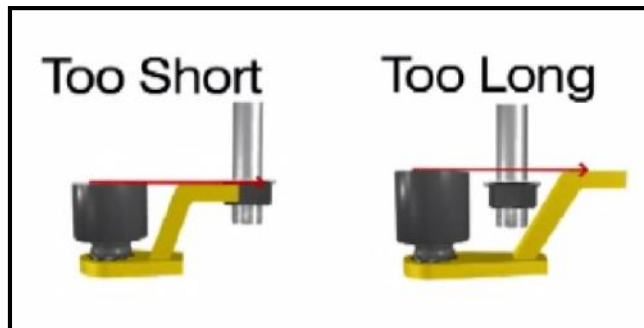

Figure 5.1.3-2: Incorrect Length

Please contact New World Technologies Inc or your local RAD Authorized Distributor for custom Reaction Arms.

5.1.4 Reaction Points

Ensure the Reaction Arm reacts off the middle of the foot as seen in Figure 5.1.4-1. Do not react off the heel of the reaction foot as seen in Figure 5.1.4-2.



CORRECT: Reaction Arm is reacting off the middle of the Reaction Arm's foot.



Figure 5.1.4-1: Correct Reaction Point

INCORRECT: Reaction Arm is reacting off the heel of the Reaction Arm. This can cause premature tool failure.

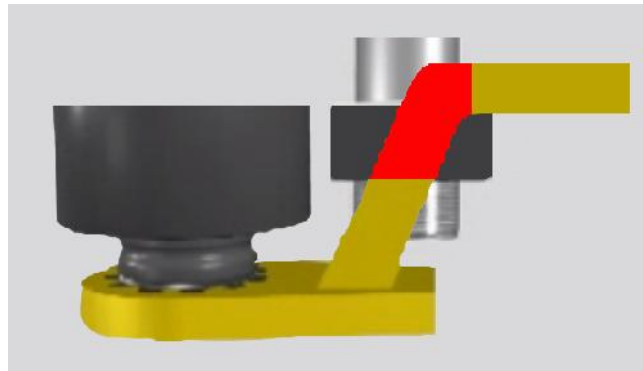

Figure 5.1.4-2: Incorrect Reaction Point

5.2 Torque Only Operation

This section describes the operation of the E-RAD Torque Only Mode. In Torque Only Mode, the Torque Cycle has passed when the Actual Torque reaches the Set Torque.

To operate the Torque Only Mode:

1. Adjust the Set Torque to the desired value by referring to Section 4.3.1 – Select a Preset, if the E-RAD is in the Locked Level, or Section 4.3.7 – Change the Set Torque, if the E-RAD is in any other level.
Note: Refer to Section 1.2.1 – Torque Ranges.
2. Adjust the Set Angle to zero if the Angle Mode is enabled. Refer to Section 4.3.1 – Select a Preset, if the E-RAD is in the Locked Level, or Section 4.3.8 – Change the Set Angle, if the E-RAD is in any other level.
3. Place the E-RAD on the joint system.
4. Ensure the Forward/Reverse Switch is in the Forward Position.
5. Ensure the blue “System Ready” LED is illuminated.
6. Press and hold the Tool Handle On/Off Trigger until the Torque Cycle has passed.

Note: To stop the E-RAD at any time during the Torque Cycle, release the On/Off Trigger. This will result in a failed Torque Cycle.

Note: After the Torque Cycle has passed or failed, the E-RAD will reverse slightly to unload the Reaction Arm.

Result: When the Torque Cycle has passed or failed, the Actual Torque (Measured Peak Torque) will be displayed on the Main Screen. Figure 5.2-1 shows the Main Screen after a passed Torque Cycle and Figure 5.2-2 shows the Main Screen after a failed Torque Cycle.



Figure 5.2-1: Passed Torque Cycle



Figure 5.2-2: Failed Torque Cycle

Note: The result will be displayed for ten seconds or until the E-RAD is reversed or a new cycle is started.

5.3 Angle Only Operation

This section describes the operation of the E-RAD Angle Only Mode. In Angle Only Mode, the Angle Cycle has passed when the Actual Angle reaches the Set Angle.

To operate in Angle Only Mode, Angle Mode must be enabled by referring to Section 4.3.11 – Enable/Disable Angle Mode.

To operate the Angle Only Mode:

1. Adjust the Set Torque to zero by referring to Section 4.3.1 – Select a Preset, if the E-RAD is in the Locked Level, or Section 4.3.7 – Change the Set Torque, if the E-RAD is in any other level.
2. Adjust the Set Angle to the desired value by referring to Section 4.3.1 – Select a Preset, if the E-RAD is in the Locked Level, or Section 4.3.8 – Change the Set Angle, if the E-RAD is in any other level.
Note: The Set Angle range is 0 degrees and 10 to 360 degrees.
3. Place the E-RAD on the joint system.
4. Ensure the Forward/Reverse Switch is in the Forward Position.
5. Ensure the blue “System Ready” LED is illuminated.
6. Press and hold the Tool Handle On/Off Trigger until the Pre-Torque Cycle has passed.

Result: The result of the Pre-Torque Cycle will be displayed on the Main Screen as shown in Figure 5.3-1.



Figure 5.3-1: Pre-Torque Cycle



- Press and hold the On/Off Trigger until the Angle Cycle has passed.
 Note: To stop the E-RAD at any time during the Angle Cycle, release the Trigger. This will result in a failed Angle Cycle.
 Note: The Angle Cycle will stop if the Actual Torque reaches the Maximum Torque of the E-RAD Model.

WARNING!

If the Angle Lock is enabled, the On/Off Trigger does not need to be held during the Angle Cycle. To stop the Angle Locked Cycle at any time, switch the Forward/Reverse Switch to the Reverse Position. This will result in a failed Angle Cycle. To pause the cycle, press the On/Off Trigger. To continue the cycle, press the On/Off Trigger again. Refer to Section 4.3.12 – Enable/Disable Angle Lock for more information on this function.

Note: After the Angle Cycle has passed or failed, the E-RAD will reverse slightly to unload the Reaction Arm.

Result: When the Angle Cycle has passed or failed, the Actual Torque and the Actual Angle (total degrees of rotation) will be displayed on the Main screen. Figure 5.3-2 shows the Main screen after a passed Angle Cycle and Figure 5.3-3 shows the Main screen after a failed Angle Cycle.



Figure 5.3-2: Passed Angle Cycle



Figure 5.3-3: Failed Angle Cycle

Note: The result will be displayed for ten seconds or until the E-RAD is reversed or a new cycle is started.

5.4 Torque and Angle Operation

This section describes the operation of the Torque and Angle Mode. The Torque and Angle Mode works differently if Increment is enabled or disabled. Refer to Section 4.3.14 – Enable/Disable Increment.

To operate in Torque and Angle Mode, Angle Mode must be enabled by referring to Section 4.3.11 – Enable/Disable Angle Mode.

5.4.1 Increment Disabled

While Increment is disabled, the E-RAD Tool System will do a Torque Cycle to the Set Torque and then an Angle Cycle to the Set Angle.

To operate the Torque and Angle Mode:

- Adjust the Set Torque to the desired value by referring to Section 4.3.1 – Select a Preset, if the E-RAD is in the Locked Level, or Section 4.3.7 – Change the Set Torque, if the E-RAD is in any other level.
 Note: Refer to Section 1.2.1 – Torque Ranges.
- Adjust the Set Angle to the desired value by referring to Section 4.3.1 – Select a Preset, if the E-RAD is in the Locked Level, or Section 4.3.8 – Change the Set Angle, if the E-RAD is in any other level.
 Note: The Set Angle range is 0 degrees and 10 to 360 degrees.
- Place the E-RAD on the joint system.
- Ensure the Forward/Reverse Switch is in the Forward Position.
- Ensure the blue “System Ready” LED is illuminated.



6. Press and hold the On/Off Trigger until the Torque Cycle has passed. This will occur when the Actual Torque reaches the Set Torque.
Note: To stop the E-RAD at any time during the Torque and Angle Cycle, release the Trigger. This will result in a failed Torque and Angle Cycle.
7. Press and hold the On/Off Trigger until the Angle Cycle has passed. This will occur when the Actual Angle reaches the Set Angle or the Actual Torque reaches the Maximum Torque of the E-RAD.
Note: The Angle Cycle will stop if the Actual Torque reaches the Maximum Torque of the E-RAD Model.

WARNING!

If the Angle Lock is enabled, the On/Off Trigger does not need to be held during the Angle Cycle. To stop the Angle Locked Cycle at any time, switch the Forward/Reverse Switch to the Reverse Position. This will result in a failed Angle Cycle. To pause the Cycle, press the On/Off Trigger. To continue the Cycle, press the On/Off Trigger again. Refer to Section 4.3.12 – Enable/Disable Angle Lock for more information on this function.

Note: After the Torque and Angle Cycle has passed or failed, the E-RAD will reverse slightly to unload the Reaction Arm.

Result: When the Torque and Angle Cycle has passed or failed, the Actual Torque (Peak Measured Torque) and the Actual Angle (Total Degrees of Rotation) will be displayed on the Main Screen. Figure 5.4.1-1 shows the Main Screen after a passed Torque and Angle Cycle and Figure 5.4.1-2 shows the Main Screen after a failed Torque and Angle Cycle.



Figure 5.4.1-1: Passed Torque and Angle Cycle



Figure 5.4.1-2: Failed Torque and Angle Cycle

Note: The result will be displayed for ten seconds or until the E-RAD is reversed or a new cycle is started.

5.4.2 Increment Enabled

While Increment is enabled, the E-RAD Tool System will pass Angle Cycles to the Maximum Angle until the Maximum Torque is reached.

To operate the Torque and Angle Mode:

1. Adjust the Maximum Torque to the desired value by referring to Section 4.3.1 – Select a Preset, if the E-RAD is in the Locked Level, or Section 4.3.7 – Change the Set Torque, if the E-RAD is in any other level.
Note: Refer to Section 1.2.1 – Torque Ranges.
2. Adjust the Maximum Angle to the desired value by referring to Section 4.3.1 – Select a Preset, if the E-RAD is in the Locked Level, or Section 4.3.8 – Change the Set Angle, if the E-RAD is in any other level.
Note: The Set Angle range is 0 degrees and 10 to 360 degrees.
3. Place the E-RAD on the joint system.
4. Ensure the Forward/Reverse Switch is in the Forward Position.
5. Ensure the blue “System Ready” LED is illuminated.



- Press and hold the Tool Handle On/Off Trigger until the Pre-Torque Cycle has passed.
Result: The result of the Pre-Torque Cycle will be displayed on the Main Screen as shown in Figure 5.4.2-1.



Figure 5.4.2-1: Pre-Torque Cycle

- Press and hold the On/Off Trigger until the Angle Cycle has passed. This will occur when the Actual Angle reaches the Maximum Angle.
Note: To stop the E-RAD at any time during the Torque and Angle Cycle, release the trigger. This will result in a failed Torque and Angle Cycle.
- Repeat step 7 until the Actual Torque reaches the Maximum Torque. When this occurs, the Angle Cycle will fail, but the Torque Cycle will pass.

WARNING!

If the Angle Lock is enabled, the On/Off Trigger does not need to be held during the Angle Cycle. To stop the Angle Locked Cycle at any time, switch the Forward/Reverse Switch to the Reverse Position. This will result in a failed Angle Cycle. To pause the cycle, press the On/Off Trigger. To continue the cycle, press the On/Off Trigger again. Refer to Section 4.3.12 – Enable/Disable Angle Lock, for more information on this function.

Note: After the Torque and Angle Cycle has passed or failed, the E-RAD will reverse slightly to unload the Reaction Arm.

Result: When the Torque and Angle Cycle has passed or failed, the Actual Torque (Peak Measured Torque) and the Actual Angle (Total Degrees of Rotation) will be displayed on the Main Screen. Figure 5.4.2-2 shows the Main Screen after a passed Torque and Angle Cycle and Figure 5.4.2-3 shows the Main Screen after a failed Torque and Angle Cycle.



Figure 5.4.2-2: Passed Torque and Angle Cycle



Figure 5.4.2-3: Failed Torque and Angle Cycle

Note: The result will be displayed for ten seconds or until the E-RAD is reversed or a new cycle is started.

5.5 Reviewing the Last Result



This function allows the operator to review the results of the last cycle performed.

To review the Last Result:

1. Select the "Last Result" text displayed above the Set Torque on the Main Screen (Figure 5.5-1). This text will appear when the display returns to the Main Screen after displaying the results of a cycle.



Figure 5.5-1: Last Result Displayed

Note: The Last Result will be displayed for ten seconds or until the E-RAD is reversed or a new cycle is started.

6.0 Data Log PC Operations

The E-RAD Data Logger allows the operator to connect the E-RAD Touch Controller to a personal computer (PC) and perform the following actions:

- Setting the Clock on the E-RAD Tool System (refer to 6.3)
- Downloading all Data Logs from the E-RAD Tool System (refer to 6.4)
- Deleting Data Logs from the E-RAD Tool System (refer to 6.5)
- Exporting Data to another program (refer to 6.6)

Note: The E-RAD Data Logger Program does not work on all operating systems; refer to Section 6.1 for more information.

6.1 Software Installation and PC Requirements

The Smart Socket PC Software can be downloaded from www.eradtorque.com, click on "E-RAD Software Download" found on the bottom right of the home page.

After the download is complete, follow the installation instructions in the INSTALL_README.txt located in the download package.

The E-RAD Touch Data Logger Software is compatible with Window XP, Vista, and Windows 7 operating systems.

The PC must have a free USB port to be used with the Serial Communications Cable (USB A to B) provided.

Note: If a physical copy is needed, request a CD copy from your Authorized RAD Distributor or New World Technologies Inc.

6.2 Connecting E-RAD and PC

To connect the E-RAD Tool System to a PC for Data Log access:

1. Connect the Serial Communication Cable from the available PC USB Port to the Communication Port on the E-RAD Controller.

Note: When the Serial Communication Cable is connected to the Communication Port on the E-RAD Controller, the E-RAD will restart. This is normal, but to prevent it, connect the cable before turning the E-RAD on.

On the E-RAD Touch Display:



2. Press the “Menu” button on the Main Screen.
3. Select “PC Transfer” from the Main Menu, shown in Figure 6.2-1.
Result: The PC Transfer Screen will be displayed (Figure 6.2-2).

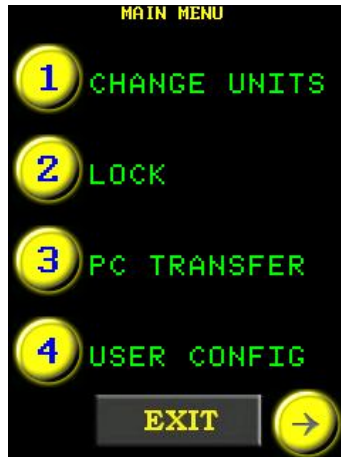

Figure 6.2-1: Main Menu

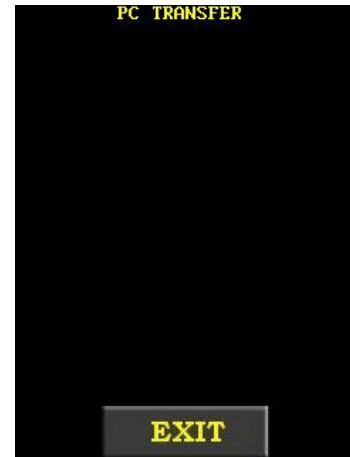

Figure 6.2-2: PC Transfer Screen

On the PC:

4. Open the Data Logger Software (Figure 6.2-3).

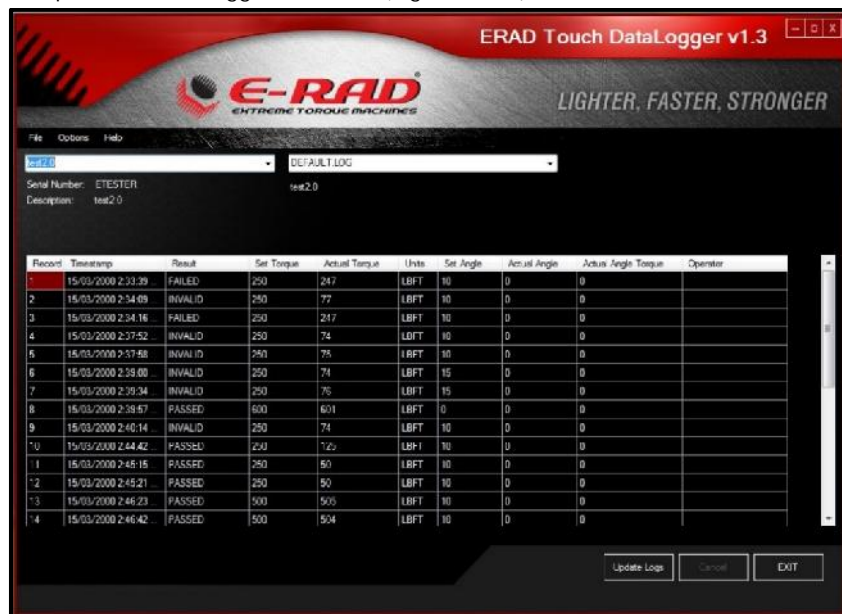

Figure 6.2-3: Data Logger Main Screen

Note: If the E-RAD is not in PC Transfer Mode, a prompt window will appear (Figure 6.2-4). Ensure the E-RAD is in PC Transfer Mode and press “OK”.

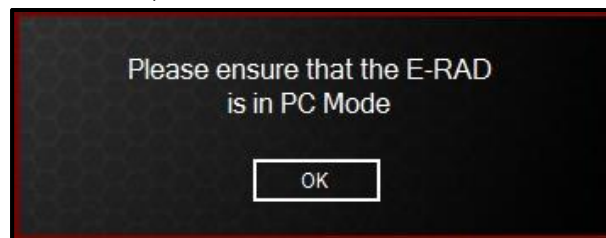

Figure 6.2-4: PC Mode Prompt Window

5. Select the “Options” drop down menu.
6. Select “Com Port” from the Options Menu (Figure 6.2-5).

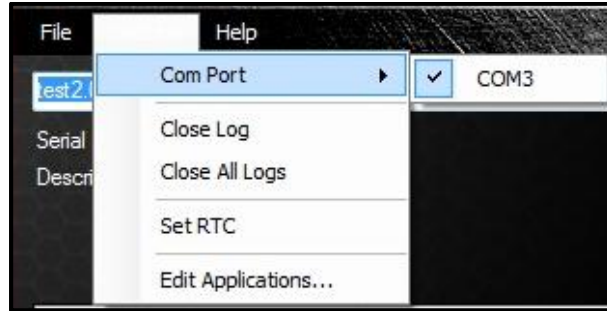

Figure 6.2-5: Com Port Selection from Options Menu

7. Select the correct Com Port for the Serial Communication Cable.

6.3 Setting the Clock

Once the E-RAD Touch Display is in PC Transfer Mode and the Data Logger Software is running (refer to Section 6.2 – Connecting E-RAD and PC), the E-RAD Data Logger Software can be used to set the time and date on the Main Screen of the E-RAD Touch Display.

To set the time and date:

1. Select the “Options” drop down menu.
2. Select “Set RTC” from the Options drop down menu (Figure 6.3-1).

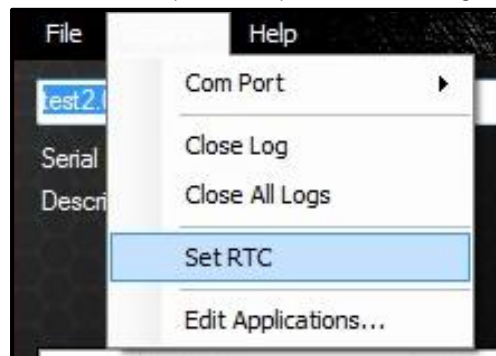

Figure 6.2-1: Set RTC from Options Menu

Result: The time and date on the E-RAD Main Screen will be updated to the time and date on the PC.

6.4 Downloading all Data Logs

Once the E-RAD Touch Display is in PC Transfer Mode and the Data Logger Software is running (refer to Section 6.2 – Connecting E-RAD and PC), the operator can download all the Data Logs from the E-RAD Touch Display to the Data Logger Software.

To download all the Data Logs (on the PC):

1. Press the “Update Logs” button on the Main Screen (Figure 6.4-1).

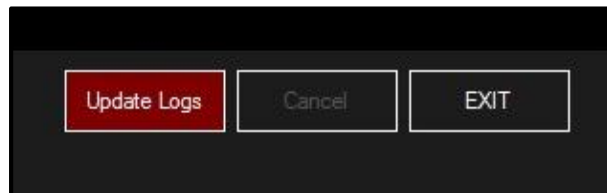

Figure 6.4-1: “Update Logs” Button

Result: The Data Logger Software will download all the Data Logs from the E-RAD Tool System. Once the Data Logs have been downloaded to the Data Logger Software, the operator will be prompted to add descriptions of the E-RAD and the Data Logs. These descriptions are useful in identifying a Data Log.

Note: All Data Logs are stored on a local database which can be accessed to further manipulate the data.



6.5 Deleting Data Logs from the E-RAD

By closing a Data Log in the Data Logger Software, the operator is also deleting the Data Log from the E-RAD Tool System. The Data Log will be saved on the PC and the title of the Data Log will be modified to indicate the date it was closed.

Note: The E-RAD must be in PC Transfer Mode and the Data Logger Software must be running before proceeding with the following instructions. Refer to Section 6.2 – Connecting E-RAD and PC.

To delete a Data Log:

1. Select the Data Log to be closed (Figure 6.5-1).



Figure 6.5-1: Select a Data Log

2. Select the "Options" drop down menu.
3. Select "Close Log" from the Options menu (Figure 6.5-2).

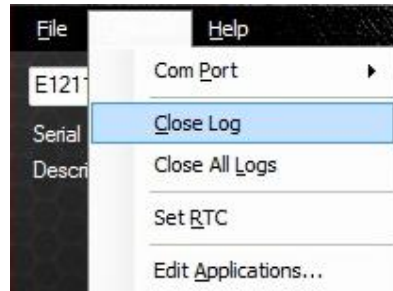

Figure 6.5-2: Close Log from Options Menu

Result: The selected Data Log will be closed in the Data Logger Software and deleted from the E-RAD Tool System.

6.6 Exporting Data

The Data Logger Software allows the operator to export the data contained within a Data Log to another program, such as Notepad, WordPad, Microsoft Word or Microsoft Excel for further manipulation.

To export data from a Data Log:

1. Select the E-RAD Tool from which the Data Log came from (Figure 6.6-1).

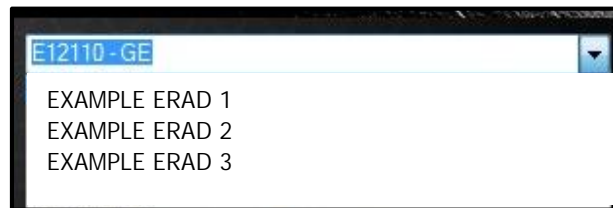

Figure 6.6-1: Select an E-RAD

2. Select the Data Log (Figure 6.6-2).



Figure 6.6-2: Select a Data Log



- Click and drag the mouse over the data to select it and then release the mouse (Figure 6.6-3).

Record	Timestamp	Result	Set Torque	Actual Torque	Units	Set Angle	Actual Angle	Actual Angle Torque	Operator
16	15/03/2000 2:47:56 ...	PASSED	250	50	_BFT	10	0	0	
17	15/03/2000 2:48:14 ...	PASSED	500	500	_BFT	10	0	0	
18	15/03/2000 2:48:29 ...	PASSED	0	2	_BFT	10	0	0	
19	15/03/2000 2:49:17 ...	FAILED	0	2	_BFT	10	0	0	
20	15/03/2000 2:49:23 ...	FAILED	0	2	_BFT	11	52	0	
21	15/03/2000 2:49:29 ...	PASSED	0	0	_BFT	11	1*	0	
22	15/03/2000 2:49:36 ...	PASSED	0	0	_BFT	11	1*	0	
23	15/03/2000 2:50:24 ...	INVALID	250	17	_BFT	12	0	0	
24	15/03/2000 2:50:33 ...	INVALID	250	15	_BFT	12	0	0	
25	15/03/2000 2:50:39 ...	PASSED	250	250	_BFT	12	12	0	
26	15/03/2000 3:03:05 ...	PASSED	250	250	_BFT	15	15	0	
27	15/03/2000 3:03:48 ...	PASSED	250	250	_BFT	15	15	0	
28	15/03/2000 3:04:17 ...	INVALID	250	250	_BFT	15	15	0	

Figure 6.6-3: Select data from Data Log

- Press "Control" + "C" to copy the data.
- Open the other program.
Suggestion: Microsoft Excel usually works best for manipulating the data which is already in a table setup.
- Press "Control" + "V" to paste the data into the program.

6.7 Uploading Operator Password File

When using the Operator Password function outlined in Section 4.3.16 – Operator Password, the operator must load an Operator Password File onto the E-RAD Tool System. When the Operator Password function is enabled, the data log files will show the operator's name if they are included in the Operator Password File.

Note: In this section, an underscore "_" represents a space. When writing this file, use spaces in place of the underscores used in these instructions. It is important to have the right spacing or the E-RAD will not be able to read the file.

To create the Operator Password File:

- Open Notepad on the PC.
- Enter the first line "PASSWORD___OPERATOR'S_NAME". See Figure 6.7-1 for an example of this first line.
Note: Do not include the quotation marks.
Note: All the letters must be capitals.
- Use the remaining lines to enter passwords and the corresponding operator names.
- Enter the first password and operator's name on the second line. Example: "12345678___OPERATOR_121212" (Figure 6.7-1).
Note: The password can be eight characters or less and the operator's name can be 15 characters or less.
Note: The start of the password lines up with the P in the first line and the start of the operator's name lines up with the O in the first line. This must be done regardless of the length of the password. Any line cannot go passed the E at the end of the first line.
Note: The operator's name column can be left blank.
- Enter more passwords and operator's names if more than one is needed. Example with a shorter password: "555_____OPERATOR_2" (Figure 6.7-1).
Note: There is no need to finish the line with spaces. Press enter to start the next line.

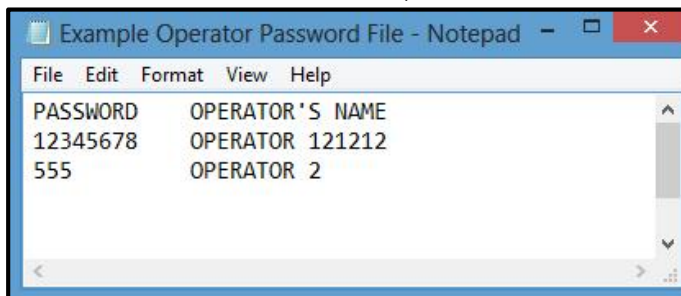

Figure 6.7-1: Example Operator Password File



6. Save this file with an appropriate name and in an appropriate location.
7. Open Data Logger Software and ensure the E-RAD Tool System is in PC Transfer Mode. Refer to Section 6.2 – Connecting E-RAD and PC.
8. Select the “File” drop down menu.
9. Select “Upload File” from the File drop down menu (Figure 6.7-2).

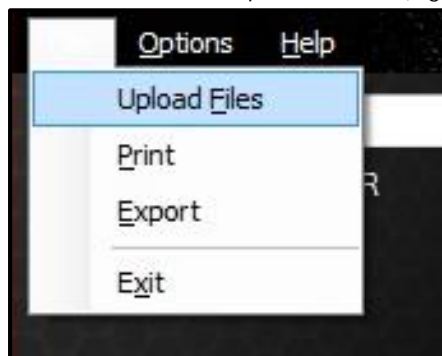

Figure 6.7-2: Upload Files from File Menu

Result: A File Explorer Window will appear (Figure 6.7-3).

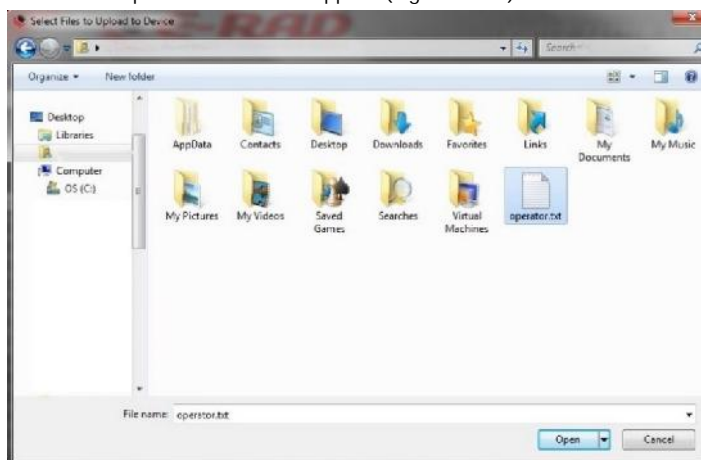

Figure 6.7-3: File Explorer Window

10. Select the Operator Password File created previously.
11. Press the “Open” button.
Result: A progress bar will appear at the bottom of the Data Logger Main Screen. After the upload is completed, a message will be displayed indicating if the upload was successful or not.

7.0 Troubleshooting

DANGER!

Electrical Shock can cause serious or fatal injury. Do not remove the E-RAD Controller Top Plate or attempt any repairs without approval and training. Do not touch any exposed power devices, electrical connections or cables.

Important!

Disassembling or attempting repair will void warranty.

7.1 Error Messages

In case of an error or problem, the E-RAD Touch Display will display an active error message, hindering tool operation. This section lists any error messages or problems that may occur and references the correct solution found in Section 7.2 – Solutions.

Note: If the problem or error persists after following solution instructions, contact New World Technologies Inc. Technical Support (refer to Section 8.0 – Contact Us).



7.1.1 Blank E-RAD Touch Display

After turning the E-RAD Tool System on, the Touch Display remains black.

Solution:

1. Ensure E-RAD Power Switch is on.
2. Refer to 7.2.2 – AC Power Cable.
3. Refer to 7.2.4 – AC Mains Power Supply.

7.1.2 Fixed in Initialization Screen

After turning the E-RAD Tool System on, the Touch Display has started up but is fixed in the Initialization Screen.

Solution: Refer to 7.2.1 – Power-Cycle.

7.1.3 FB Not Ready/Analog Sensor

The E-RAD Controller is not receiving feedback from the Tool Handle.

Solution: Refer to 7.2.3 – Tool Handle Motor and Feedback Cables.

7.1.4 Feedback Loss

The E-RAD Controller has lost the feedback signal from the Tool Handle.

Solution: Refer to 7.2.3 – Tool Handle Motor and Feedback Cables.

7.1.5 Overspeed

The motor is moving faster than the expected during a cycle. This is usually caused by a loss of feedback from the motor to the servo driver.

Solution: Refer to 7.2.3 – Tool Handle Motor and Feedback Cables.

7.1.6 Position Error

The motor is not in the expected position. This is usually caused by a loss of feedback from the motor to the servo driver.

Solution: Refer to 7.2.3 – Tool Handle Motor and Feedback Cables.

7.1.7 Position Limit Exceeded

The motor position exceeded the expected motor movement during an Angle Cycle.

Solution: Refer to 7.2.3 – Tool Handle Motor and Feedback Cables.

7.1.8 Motor Stuck

The servo driver is unable to rotate the motor. This is usually caused by a loss of feedback or power from the motor to the servo driver.

Solution: Refer to 7.2.3 – Tool Handle Motor and Feedback Cables.

7.1.9 Peak Current Exceeded

The E-RAD Controller or Tool Handle current draw has exceeded the maximum limit (15A).

Solution:

1. Refer to 7.2.3 – Tool Handle Motor and Feedback Cables.
2. Refer to 7.2.2 – AC Power Cable.
3. Refer to 7.2.4 – AC Mains Power Supply.
4. Refer to 7.2.1 – Power-Cycle.

7.1.10 Inhibited

The servo driver is unable to rotate the motor. This is usually caused by a loss of feedback or power from the motor to the servo driver.

Solution: Refer to 7.2.1 – Power-Cycle.

7.1.11 Motor Cannot Start

The servo driver is unable to rotate the motor. This is usually caused by a loss of feedback or power from the motor to the servo driver.

Solution: Refer to 7.2.1 – Power-Cycle.



7.1.12 DB Inconsistent

An intermittent fault in the AC/DC conversion has resulted in unexpected changes in signal amplification.

Solution:

1. Refer to 7.2.2 – AC Power Cable.
2. Refer to 7.2.4 – AC Mains Power Supply.
3. Refer to 7.2.1 – Power-Cycle.

7.1.13 Under Voltage

The DC power provided to the motor does not meet the requirements.

Solution:

1. Refer to 7.2.2 – AC Power Cable.
2. Refer to 7.2.4 – AC Mains Power Supply.
3. Refer to 7.2.1 – Power-Cycle.

7.1.14 Over Voltage

The DC power provided to the motor exceeds the limitations.

1. Refer to 7.2.2 – AC Power Cable.
2. Refer to 7.2.4 – AC Mains Power Supply.
3. Refer to 7.2.1 – Power-Cycle.

7.1.15 Short Circuit

Immediately power off the E-RAD and remove from service. Contact New World Technologies Inc. Technical Support (refer to Section 8.0 – Contact Us).

7.1.16 Over Temp

The E-RAD Controller's Internal Temperature has exceeded its maximum.

Solution: Refer to 7.2.5 – Needs Cooling

7.1.17 "Internal Error" or "Program Error"

An "Internal Error" could be any of the following messages:

- Controller Comms – loss of communication between control modules
- Comms Lost – loss of communication between control modules
- NVRam Lost – corrupt memory in the Rabbit module resulting in loss of data
- Unknown Err
- Stack Overflow – program crashed
- CPU Fatal Exception – Rabbit failure

Solution: Refer to 7.2.1 – Power-Cycle

7.1.18 "Watchdog Tripped"

The AC/DC conversion is not resulting as expected.

Solution:

1. Refer to 7.2.6 – Forward/Reverse Switch
2. Refer to 7.2.1 – Power-Cycle

7.2 Solutions

DANGER!

Electrical Shock can cause serious or fatal injury. Do not remove the E-RAD Controller Top Plate and make any repairs without approval and training. Do not touch any exposed power devices, electrical connections or cables.

The following solutions may help solve the errors described in Section 7.1 – Error Messages. If the error persists after following the given solution instructions, contact New World Technologies Inc. Technical Support (refer to Section 8.0 – Contact Us).

7.2.1 Power-Cycle

To Power-Cycle the E-RAD Tool System:

1. Switch the Power Switch to the Off Position.



2. Wait two minutes.
3. Switch the Power Switch to the On Position and re-try.

7.2.2 AC Power Cable

To check the AC Power Cable:

1. Switch the Power Switch to the Off Position and wait two minutes before proceeding.
2. Remove the AC Power Cable from the AC Mains Power and then from the AC Mains Input Power Connector on the side of the E-RAD Touch Controller.
3. Check the visual condition of the AC Power Cable and the pins in the AC Mains Input Power Connector. Ensure there are no cuts or breaks in the cable insulating jacket and the pins are present and in good condition.
4. Connect the AC Power Cable to the AC Mains Input Power Connector.
5. Ensure the connection is locked tight.
6. Connect the AC Power Cable to the AC Mains Power.
7. Switch the Power Switch to the On Position and re-try.

7.2.3 Tool Handle Motor and Feedback Cables

To check the Tool Handle Motor and Feedback Cables:

1. Switch the Power Switch to the Off Position and wait two minutes before proceeding.
2. Remove the Tool Handle Motor and Feedback from the Feedback and Motor Power Connectors on the side of the E-RAD Controller.
3. Check the visual condition of the Tool Handle Motor and Feedback Cables and the pins in the Feedback and Motor Power Connectors. Ensure there are no cuts or breaks in the cable insulating jacket and the pins are present and in good condition.
4. Connect the Tool Handle Motor and Feedback Cables to the Feedback and Motor Power Connectors.
5. Ensure the connections are locked tight.
6. Switch the Power Switch to the On Position and re-try.

7.2.4 AC Mains Power Supply

To check the AC Mains Power Supply:

1. Ensure the AC Mains Power Supply is present and within specifications.
2. Ensure the AC Mains Power Supply branch is a dedicated 15A with no other appliances connected.

Note: If an AC Mains Extension Cord is in use, ensure it meets the minimum E-RAD specifications for length and gage outlined in Section 2.4 – Extension Cords.

7.2.5 Needs Cooling

To cool the E-RAD Tool System:

1. Ensure the Controller Cooling Fans are functional and the filter covers are not blocked.
2. Switch the Power Switch to the Off Position until the temperature of the system is within specifications.

7.2.6 Forward/Reverse Switch

To reset using the Forward/Reverse Switch:

1. Switch the Forward/Reverse Switch to the Reverse Position.
2. Switch the Forward/Reverse Switch to the Forward Position.
3. Re-try.



8.0 Contact Us

New World Technologies Inc.
30580 Progressive Way
Abbotsford, BC, V2T 6Z2
Canada



Toll Free: 1-800-983-0044

Fax: 604-852-0269

Email: info@radtorque.com

Web: www.eradtorque.com

New World Technologies Inc. Technical Support: 1-800-983-0044
(Ext. 227)

Email: eradsupport@radtorque.com

